

STIHL[®]

STIHL MS 661 C-M

Instruction Manual



Contents

Guide to Using this Manual	2	Specifications	44
Safety Precautions	3	Ordering Spare Parts	45
Reactive Forces	8	Maintenance and Repairs	45
Working Techniques	9	Disposal	46
Cutting Attachment	18	EC Declaration of Conformity	46
Mounting the Bar and Chain	19		
Tensioning the Chain	20		
Checking Chain Tension	20		
Fuel	20		
Fueling	21		
Chain Lubricant	23		
Filling Chain Oil Tank	23		
Checking Chain Lubrication	24		
Chain Brake	24		
Winter Operation	25		
Electric Handle Heating	26		
Starting / Stopping the Engine	27		
Operating Instructions	30		
Oil Quantity Control	31		
Taking Care of the Guide Bar	32		
Remove Air Filter	32		
Cleaning the Air Filter	33		
M-Tronic	33		
Spark Arresting Screen in Muffler	34		
Spark Plug	35		
Storing the Machine	36		
Checking and Replacing the Chain Sprocket	36		
Maintaining and Sharpening the Saw Chain	37		
Maintenance and Care	41		
Main Parts	43		

Dear Customer,

Thank you for choosing a quality engineered STIHL product.

It has been built using modern production techniques and comprehensive quality assurance. Every effort has been made to ensure your satisfaction and trouble-free use of the product.

Please contact your dealer or our sales company if you have any queries concerning this product.

Your



Dr. Nikolas Stihl

STIHL®

MS 661 C-M

This instruction manual is protected by copyright. All rights reserved, especially the rights to reproduce, translate and process with electronic systems.

Guide to Using this Manual

This Instruction Manual refers to a STIHL chain saw, also called a machine in this Instruction Manual.

Pictograms

Pictograms that appear on the machine are explained in this Instruction Manual.

Depending on the machine and equipment version, the following pictograms may appear on the machine.



Fuel tank; fuel mixture of gasoline and engine oil



Tank for chain oil; chain oil



Engage and release chain brake



Coasting brake



Direction of chain travel



Ematic; chain oil flow adjustment



Tension saw chain



Intake air baffle: winter operation



Intake air baffle: summer operation



Handle heating

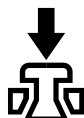

Actuate decompression valve

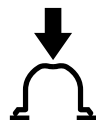

Actuate manual fuel pump

Symbols in text



WARNING

Warning where there is a risk of an accident or personal injury or serious damage to property.



NOTICE

Caution where there is a risk of damaging the machine or its individual components.

Engineering improvements

STIHL's philosophy is to continually improve all of its products. For this reason we may modify the design, engineering and appearance of our products periodically.

Therefore, some changes, modifications and improvements may not be covered in this manual.

Safety Precautions



Special safety precautions must be observed to reduce the risk of personal injury when working with a chain saw because of the very high chain speed and very sharp cutters.



It is important that you read the instruction manual before first use and keep it in a safe place for future reference. Non-observance of the instruction manual may result in serious or even fatal injury.

General

Observe all applicable local safety regulations, standards and ordinances.

The use of noise emitting power tools may be restricted to certain times by national or local regulations.

If you have not used this model before: Have your dealer or other experienced user show you how to operate your machine or attend a special course in its operation.

Minors should never be allowed to use a chain saw.

Keep bystanders, especially children, and animals away from the work area.

The user is responsible for avoiding injury to third parties or damage to their property.

Do not lend or rent your chain saw without the instruction manual. Be sure that anyone using it understands the information contained in this manual.

To operate a chain saw you must be rested, in good physical condition and mental health. If you have any condition that might be aggravated by strenuous work, check with your doctor before operating a chain saw.

Do not operate the chain saw if you are under the influence of any substance (drugs, alcohol) which might impair vision, dexterity or judgment.

To reduce the risk of accidents or injury, put off the work in poor weather conditions (rain, snow, ice, wind).

Persons with pacemakers only: The ignition system of your chain saw produces an electromagnetic field of a very low intensity. This field may interfere with some pacemakers. To reduce health risks, STIHL recommends that persons with pacemakers consult their physician and the pacemaker manufacturer before operating this power tool.

Intended use

The machine may only be used to saw wood and wooden objects.

Do not use the machine for any other purpose – risk of accidents!

Do not modify the machine in any way – this may increase the risk of personal injury. STIHL excludes all liability for personal injury and damage to property caused while using unauthorised attachments.

Clothing and Equipment

Wear proper protective clothing and equipment.



Clothing must be sturdy and snug-fitting, but allow complete freedom of movement. Wear snug fitting clothing with **cut-retardant pads** – no loose-fitting jacket.

Avoid clothing that could get caught on branches, brush or moving parts of the machine. Do not wear a scarf, necktie or jewellery. Tie up and confine long hair (headscarf, cap, hard hat, etc.).



Wear suitable **safety shoes** – with cut-retardant material, non-slip soles and steel toe caps.



WARNING



To reduce the risk of eye injuries, wear tight-fitting safety goggles conforming to standard EN 166 or a face shield. Make sure that the safety goggles and the face shield fit correctly.

Wear "personal" hearing protection – for example, ear defenders.

Wear a hard hat wherever there is any risk of falling objects.



Wear sturdy protective gloves made of a resistant material (e.g. leather).

STIHL can supply a comprehensive range of personal protective equipment.

Transport

Before any transport – even over short distances – switch off the machine, engage the chain brake and attach the chain scabbard. This avoids the risk of the saw chain starting unintentionally.

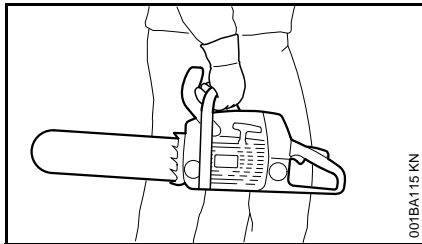

Always carry the chain saw by the handle – with the hot muffler away from your body, the guide bar must point to the rear. Avoid touching hot parts of the machine, especially the surface of the muffler – risk of burns!

In vehicles: Properly secure the machine to prevent tipping, damage and chain oil or fuel spillage.

Cleaning

Clean plastic parts with a cloth. Harsh detergents can damage the plastic.

Clean the dust and dirt off the machine – do not use any grease solvents for this purpose.

Clean the ventilation slots if necessary.

Do not use a high-pressure cleaner to clean the machine. The hard jet of water can damage parts of the machine.

Accessories

Only use those tools, guide bars, chains, chain sprockets, accessories or technically equivalent components that have been approved by STIHL for this machine. If you have any questions in this respect, consult a servicing dealer. Use only high quality tools and accessories. Otherwise, there may be a risk of accidents and damage to the machine.

STIHL recommends the use of genuine STIHL tools, guide bars, chains, chain sprockets and accessories. They are specifically designed to match your model and meet your performance requirements.

Refuelling



Gasoline is an extremely flammable fuel – keep clear of naked flames and fire – do not spill any fuel – no smoking.

Switch off the engine before refuelling.

Never refuel the machine while the engine is still hot – the fuel may spill over – **risk of fire!**

Open the fuel filler cap carefully so that any excess pressure is relieved gradually and fuel does not splash out.

The machine may only be refuelled in a well ventilated place. Clean the machine immediately if fuel is spilled. Do not spill fuel over your clothing – contaminated clothing must be changed immediately.

The machines can be equipped with the following filler caps as standard:

Cliplock filler cap (bayonet-type)

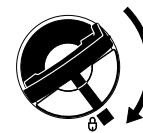

Place the cliplock filler cap (bayonet-type) in position, turn as far as stop and fold the cliplock down.

This helps reduce the risk of unit vibrations causing an incorrectly tightened filler cap to loosen or come off and spill quantities of fuel.



Look out for leaks! Never start the engine if fuel has been spilled or is leaking – **Fatal burns may result!**

Before Starting Work

Check that your saw is properly assembled and in good condition – refer to appropriate chapters in the instruction manual.

- Check the fuel system for leaks, paying special attention to visible parts such as the tank cap, hose connections and the manual fuel pump (on machines so equipped). If

there are any leaks or damage, do not start the engine – **risk of fire**. Have your saw repaired by a servicing dealer before using it again.

- Check operation of chain brake, front hand guard
- Correctly mounted guide bar
- Correctly tensioned chain
- The trigger and trigger lockout must move freely and spring back to the idle position when they are released.
- Master Control lever must move easily to **STOP, 0** or 
- Check that the spark plug boot is secure – a loose boot may cause arcing that could ignite combustible fumes **and cause a fire**.
- Never attempt to modify the controls or safety devices in any way.
- Keep the handles dry and clean – free from oil and dirt – for safe control of the saw.
- Make sure there is sufficient fuel and chain oil in the tanks.

To reduce the risk of personal injury, do not operate your saw if it is damaged or not properly assembled.

Starting the chain saw

Always work on a level surface. Ensure a firm and secure footing. Hold the machine securely – the chain must not touch any objects or the floor – danger of injury due to the rotating saw chain.

Your chain saw is a one-person saw. Do not allow other persons to be in the working area – not even while starting.

Do not start the chain saw if the chain is in a cut.

Move at least 3 meters away from the place where the machine was refuelled and never start the motor in enclosed spaces.

Lock the chain with the chain brake before starting – **risk of injury** due to rotating chain!

Do not drop-start the engine – start as described in the Instruction Manual.

During operation

Ensure you always have a firm and safe footing. Take special care when the bark is wet – **danger of slipping!**

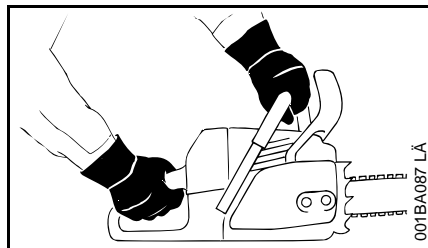

Always hold the chain saw **firmly with both hands**: Right hand on the rear handle – even if you are left-handed. To ensure reliable control, wrap your thumbs tightly around the handlebar and handle.

In the event of impending danger or in an emergency, switch off the engine immediately by moving the Master Control lever / stop switch to **STOP, 0** or .

Never let the machine run unattended.

Exercise caution with slippery surfaces, water, snow, ice, steep slopes, uneven ground or green wood that has just been stripped of its bark – **danger of slipping!**

Use caution with tree stumps, roots, ditches – **danger of stumbling!**

Do not work alone – keep within calling distance of others who are trained in emergency procedures and can provide help in an emergency. Helpers at the cutting site must also wear protective clothing (helmet!) and stand well clear of the branches being cut.

More care and attention than usual are required when wearing ear protection, as warning sounds (shouts, beeps, etc.) cannot be heard properly.

Take a break in good time to avoid tiredness or exhaustion – **risk of accidents!**

Dust (e. g., sawdust), fumes and smoke produced while using the machine may be hazardous to health. If dust is generated, wear a dust mask.

When the engine is running: Note that the saw chain continues to rotate for a short period after you let go of the throttle trigger – coasting effect.

No smoking when working with or near the chain saw - **risk of fire!** Combustible fuel vapour may escape from the fuel system.

Examine the saw chain periodically at short intervals and as soon as you note any tangible changes:

- Switch off the engine; wait until the saw chain is stationary
- Check condition and secure fitting
- Check sharpness

Never touch the saw chain when the engine is running. If the saw chain becomes jammed by an object, switch off the engine immediately before attempting to remove the object – **risk of injury!**

Always turn off the engine before leaving the machine unattended.

To change the saw chain, switch off the engine. **Risk of injury** from the motor starting unintentionally!

Keep easily combustible materials (e. g., wood chips, bark, dry grass, fuel) away from hot exhaust gases and hot mufflers – **risk of fire!** Mufflers with catalytic converters can become especially hot.

Never work without chain lubrication – monitor the oil level in the oil tank. Stop work immediately if the oil level in the oil tank is too low and top up with chain oil – see also "Topping up with chain oil" and "Check chain lubrication".

If the machine is subjected to unusually high loads for which it was not designed (e. g., heavy impact or a fall), always check that it is in good condition before continuing work – see also "Before starting work".

Check the fuel system for leaks and make sure the safety devices are working properly. Never continue using

a machine that is not in perfect working order. In case of doubt, have the unit checked by your servicing dealer.

Check for correct idling, so that the saw chain stops moving when the throttle trigger is released. Check the idle setting regularly and correct when possible. Have the machine repaired by a STIHL servicing dealer if the saw chain still continues to move during idling.



The chain saw produces poisonous exhaust gases as soon as the engine starts. These gases may be colourless and odourless and may contain unburnt hydrocarbons and benzene. Never work with the machine indoors or in poorly ventilated areas, even if your machine is equipped with a catalytic converter.

Ensure proper ventilation when working in trenches, hollows or other confined locations – **risk of fatal injury from breathing toxic fumes!**

If you feel sick, have a headache, vision problems (e. g., your field of vision gets smaller), hearing problems, dizziness or inability to concentrate, stop work immediately. Such symptoms may be caused by an excessively high concentration of exhaust emissions – **risk of accident!**

After finishing work

Switch off the motor, engage the chain brake and attach the chain scabbard.

Storage

When the machine is not in use, it should be stored in such a way that no-one is endangered. Secure the machine against unauthorised use.

Store the machine in a safe, dry room.

Vibrations

Prolonged use of the power tool may result in vibration-induced circulation problems in the hands (whitefinger disease).

No general recommendation can be given for the length of usage because it depends on several factors.

The period of usage is prolonged by:

- Hand protection (wearing warm gloves)
- Work breaks

The period of usage is shortened by:

- Any personal tendency to suffer from poor circulation (symptoms: frequently cold fingers, tingling sensations).
- Low outside temperatures.
- The force with which the handles are held (a tight grip restricts circulation).

Continual and regular users should monitor closely the condition of their hands and fingers. If any of the above symptoms appear (e.g. tingling sensation in fingers), seek medical advice.

Maintenance and repairs

Always switch off the engine before any repair, cleaning or maintenance work and any work on the chain. **Risk of injury** if the engine starts inadvertently!

The machine must be serviced regularly. Do not attempt any maintenance or repair work not described in the Instruction Manual. All other work should be carried out by a servicing dealer.

STIHL recommends that maintenance and repair work be carried out only by authorised STIHL dealers. STIHL dealers receive regular training and are supplied with technical information.

Use only high-quality spare parts. Otherwise, there may be a risk of accidents and damage to the machine. If you have any questions in this respect, consult a servicing dealer.

Do not modify the machine in any way – this may increase the risk of personal injury – **risk of accidents!**

To reduce the **risk of fire** due to ignition outside the cylinder, move the master control level to **STOP, 0** or **⊖** before turning the engine over on the starter when the spark plug boot is removed or the spark plug is unscrewed!

Do not service or store the machine near a naked flame – **risk of fire** due to the fuel!

Check fuel cap regularly for tightness.

Use only spark plugs that are in perfect condition and have been approved by STIHL – see "Specifications".

Check ignition lead (insulation in good condition, secure connection).

Check that the muffler is in perfect working condition.

Do not use the machine if the muffler is damaged or missing – **risk of fire, damage to hearing!**

Never touch a hot muffler – **risk of burns!**

The condition of the anti-vibration elements influences vibration behaviour – inspect anti-vibration elements periodically.

Inspect chain catcher – replace if damaged.

Switch off the engine

- To check the chain tension
- To retension the chain
- To replace the chain
- For remedying malfunctions

Observe sharpening instructions – for safe and proper handling, always keep the chain and guide bar in flawless condition. Keep the chain properly sharpened, tensioned and well lubricated.

Change chain, guide bar and chain sprocket in due time.

Regularly check that the clutch drum is in perfect working condition.

Always store fuel and chain lubricant only in the specified type of containers and ensure they are correctly labelled. Store in a dry, cool and secure place protected against light and sunlight.

In the event of a chain brake malfunction, switch off the machine immediately – **risk of injury!** Consult a

servicing dealer – do not use the machine until the malfunction has been remedied, see "Chain brake".

Reactive Forces

The most common reactive forces are: kickback, pushback and pull-in.

Dangers of kickback



Kickback can result in fatal cuts.

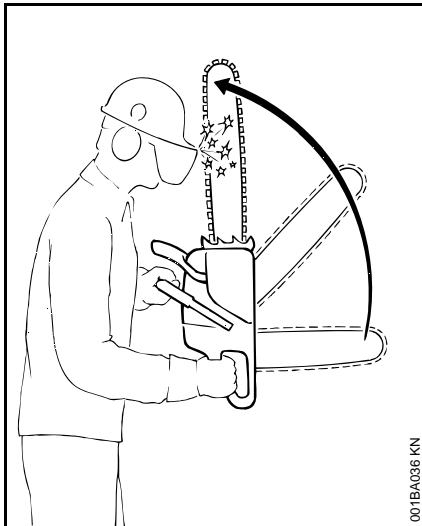

Kickback occurs when the saw is suddenly thrown up and back in an uncontrolled arc towards the operator.

Kickback occurs if, for example,

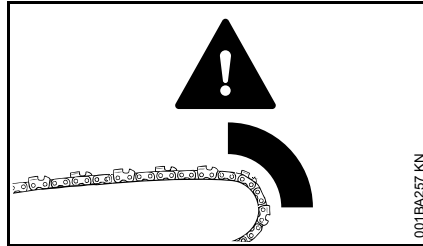

- The saw chain in the area of the upper quarter of the guide bar nose unintentionally comes into contact with wood or a solid object – e. g., unintentionally touches another limb during limbing
- The saw chain at the nose of the guide bar is briefly pinched in the cut

QuickStop chain brake:

This device reduces the risk of injury in certain situations – it cannot prevent kickback. If activated, the brake stops the saw chain within a fraction of a second – refer to chapter "Chain brake" in this Instruction Manual.

Reducing the risk of kickback

- Work cautiously and methodically
- Hold the chain saw firmly with both hands and maintain a secure grip
- Always cut at full throttle
- Be aware of the location of the guide bar nose
- Do not cut with the guide bar nose

- Be especially careful with small, tough limbs, undergrowth and offshoots – the saw chain may become caught in them
- Never cut several limbs at once
- Do not lean too far forward
- Do not cut above shoulder height
- Use extreme caution when re-entering a previous cut
- Do not attempt plunge cuts if you are not experienced in this cutting technique
- Be alert for shifting of the log or other forces that may cause the cut to close and pinch the chain
- Always cut with a correctly sharpened, properly tensioned saw chain – the depth gauge setting must not be too large
- Use low-kickback saw chains as well as narrow-radius guide bars

Pull-in (A)

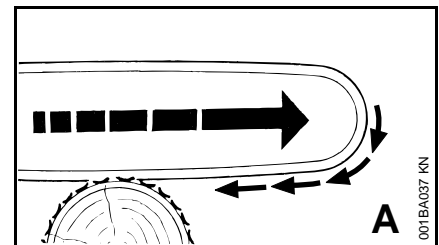

When the chain on the bottom of the bar – overbucking – is suddenly pinched, caught or encounters a foreign object in the wood, the chain saw may suddenly

be drawn forward toward the log – **to avoid this, engage the bumper spike firmly in the wood.**

Pushback (B)

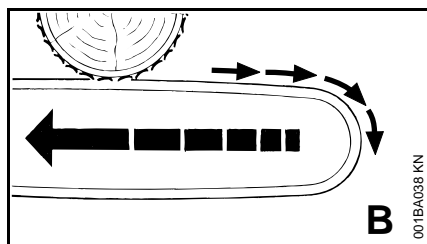

When the chain on the top of the bar – underbucking – is suddenly pinched, caught or encounters a foreign object in the wood, the chain saw may suddenly be driven straight back toward the operator – **to avoid this:**

- Do not allow the top of the guide bar to become jammed
- Do not twist the guide bar in the cut

Be very careful

- With freely hanging limbs
- With trunks that are under tension between other trees because they fell unfavourably
- When working in windbreaks

In these cases, do not use a chain saw – use a hoist, winch or dragline instead.

Pull out trunks that are lying about and have been cut free. Whenever possible, deal with them in open areas.

Dead wood (brittle, rotten or dead wood) poses a significant, highly unpredictable hazard. It is extremely difficult or even practically impossible to recognise the danger. Use aids such as winches or draglines.

When **felling close to roads, rail lines, power lines**, etc., work with particular care. If necessary, notify police, power companies or railway authorities.

Working Techniques

Sawing and felling work, including all related work (plunge cutting, limbing, etc.) may only be carried out by persons who have been specially trained and instructed. Persons who are not experienced chain saw users should not carry out any such work – increased risk of accidents!

Country-specific legislation on felling technique must be complied with during felling work.

Cutting

Do not operate your saw with the starting throttle lock engaged. Engine speed cannot be controlled with the throttle trigger in this position.

Work calmly and carefully – in daylight conditions and only when visibility is good. Ensure you do not endanger others – stay alert at all times.

First-time users are advised to practice cutting logs on a sawhorse – see "When cutting small logs".

Use the shortest possible guide bar: The chain, guide bar and chain sprocket must match each other and your saw.

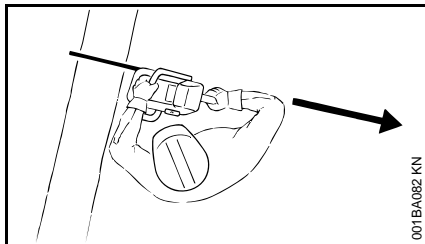

Position the saw so that your body is **clear of the cutting attachment.**

Always pull the saw out of the cut with the chain running.

Use your chain saw for cutting only. It is not designed for prying or shoveling away limbs, roots or other objects.

Do not underbuck freely hanging limbs.

Take care when cutting scrub and young trees. The saw chain may catch and throw thin shoots in your direction.

To reduce the risk of injury, take special care when cutting shattered wood because of the risk of injury from splinters being caught and thrown in your direction.

Make sure your saw does not touch any foreign materials: Stones, nails, etc. may be flung off and damage the saw chain. The saw may kick back unexpectedly – **risk of accidents.**

If the rotating chain makes contact with a rock or other solid object there is a risk of sparking which may cause easily combustible material to catch fire under certain circumstances. Dry plants and scrub are also easily combustible, especially in hot and dry weather conditions. If there is a risk of fire, do not use your chainsaw near combustible

materials, dry plants or scrub. Always contact your local forest authority for information on a possible fire risk.

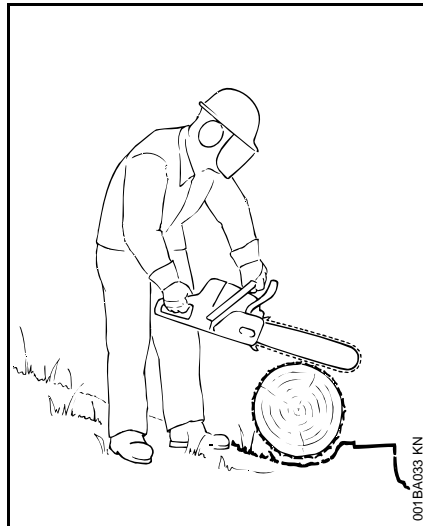

If on a slope, stand on the uphill side of the log. Watch out for rolling logs.

When working at heights:

- Always use a lift bucket
- Never work on a ladder or in a tree
- Never work on an insecure support
- Do not work above shoulder height
- Never operate your power tool with one hand

Begin cutting with the saw at full throttle and engage the spiked bumper firmly in the wood, and then continue cutting.

Never work without the spiked bumper because the saw may pull you forwards and off balance. Always engage the spiked bumper securely in the tree or limb.

Note when reaching the end of a cut that the saw is no longer supported in the kerf. You have to take the full weight of the machine since **it might otherwise go out of control.**

When cutting small logs:

- Use a sturdy and stable support – sawhorse.
- Never hold the log with your leg or foot.
- Never allow another person to hold the log or help in any other way.

Limbing:

- Use a low kickback chain.
- Work with the saw supported wherever possible.
- Do not stand on the log while limbing it.
- Do not cut with the bar nose.
- Watch for limbs which are under tension.
- Never cut several limbs at once.

Lying or standing logs under tension:

Always make cuts in the correct sequence (first at the compression side (1), then at the tension side (2), the saw may otherwise pinch or kick back – **risk of injury.**

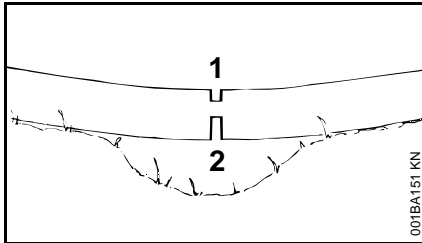

001BA151 KN

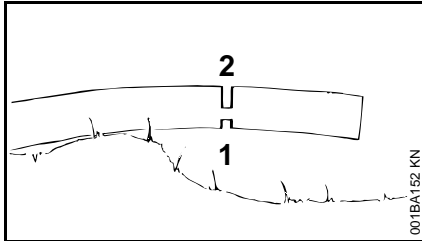

001BA152 KN

- Make relieving cut at the compression side (1)
- Make bucking cut at the tension side (2)

Be wary of **pushback** when making bucking cut from the bottom upwards (underbuck).



NOTICE

Do not cut a lying log at a point where it is touching the ground because the saw chain will otherwise be damaged.

Ripping cut:

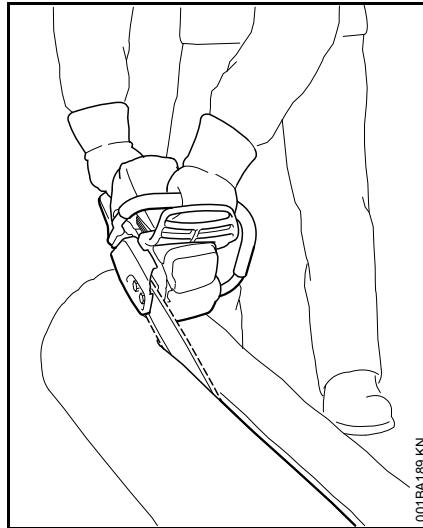

001BA189 KN

Cutting technique in which the spiked bumper is not used – risk of pull-in – start the cut with the guide bar at the shallowest possible angle – take extra care since there is an increased **danger of kickback**.

Preparations for Felling

Check that there are no other persons in the felling area – other than helpers.

Make sure no-one is endangered by the falling tree – the noise of your engine may drown any warning calls.

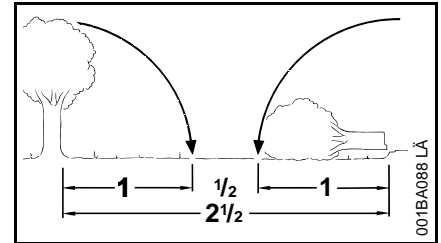

001BA088 LA

Maintain a distance of at least 2 1/2 tree lengths from the next felling site.

Determine direction of fall and escape path.

Select gap in stand into which you want the tree to fall.

Pay special attention to the following points:

- The natural lean of the tree
- Any unusually heavy limb structure, damage
- The wind direction and speed – do not fell in high winds
- Sloping ground
- Neighboring trees
- Snow load
- Soundness of tree – take special care if trunk is damaged or in case of deadwood (dry, decayed or rotted wood)

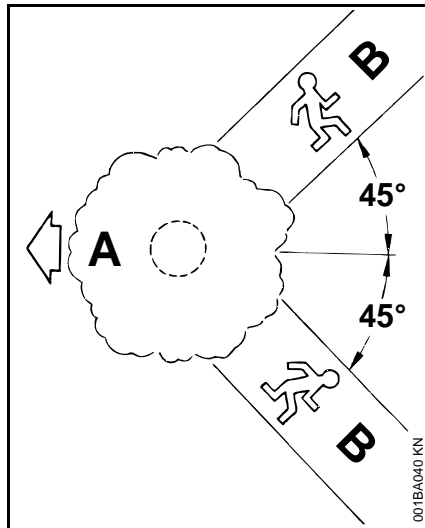

- A** Direction of fall
- B** Escape path (or retreat path)
- Establish paths of escape for everyone concerned – opposite to direction of fall at about 45°.
- Remove all obstacles from escape paths.
- Place all tools and equipment a safe distance away from the tree, but not on the escape paths.
- Always keep to the side of the falling tree and only walk away along the preplanned escape path.
- On steep slopes, plan escape routes parallel to the slope.
- When walking away along the escape path, watch out for falling limbs and watch the top of the tree.

Preparing work area at base of tree

- First clear the tree base and work area from interfering limbs and brush to provide a secure footing.
- Clean lower portion of tree base (e.g. with an axe) – sand, stones and other foreign objects will dull the saw chain.

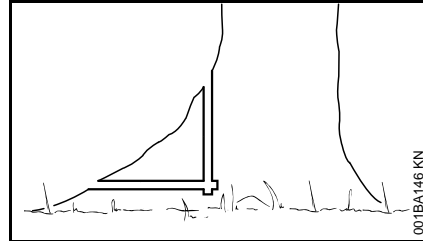

- Make the vertical cut first, then the horizontal – but only if the wood is sound

Felling Notch

Preparing felling notch

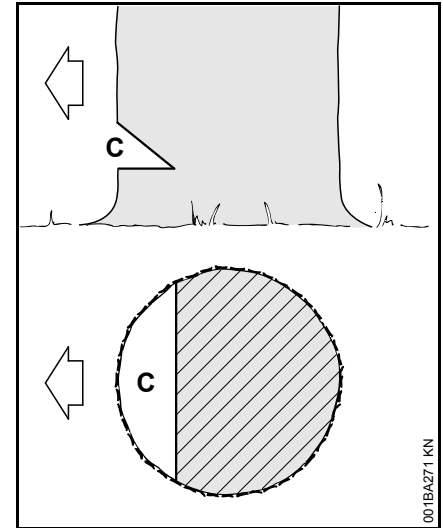

The felling notch (C) determines the direction of fall.

Important:

- Make felling notch at a right angle to the planned direction of fall.
- Cut close to the ground.
- Cut to a depth of about 1/5 to 1/3 of the trunk diameter.

Determine direction of fall with gunning sight on shroud and fan housing

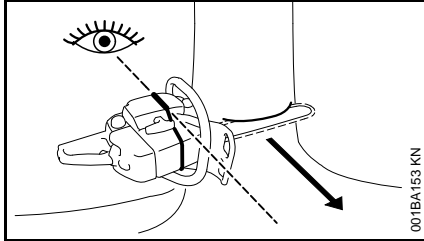

Your chainsaw has a gunning sight on the shroud and fan housing. Use this gunning sight.

Making Felling Notch

Position the saw so that the felling notch is at a right angle to the direction you want the tree to fall.

The sequence in which the felling notch is made with a horizontal cut (bottom) and angled cut (top) is defined in country-specific regulations.

- Make horizontal cut (bottom)
- Make the angled cut (top) at about 45° - 60° to the horizontal cut.

Check direction of fall

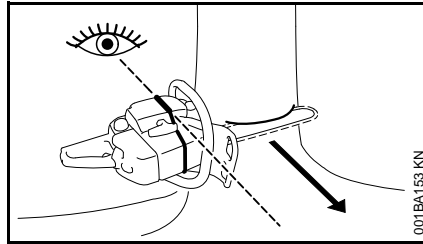

- Position the saw in the horizontal cut. The gunning sight must point in the planned direction of fall – if necessary, correct direction of fall by re-cutting the felling notch.

Sapwood cuts

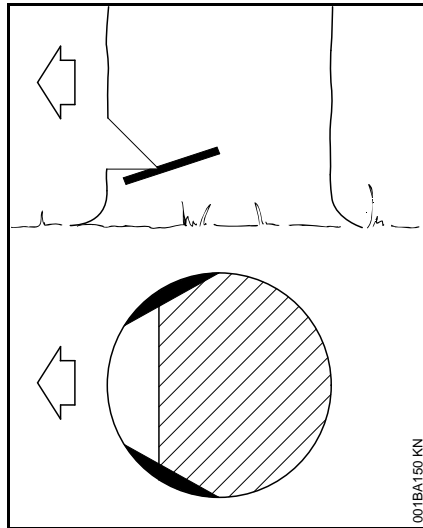

Sapwood cuts in long-fibered softwood help prevent sapwood splintering when the tree falls. Make cuts at both sides of the trunk at same height as bottom of

felling notch to a depth of about 1/10 of trunk diameter. On large diameter trees, cut to no more than width of guide bar.

Do not make sapwood cuts if wood is diseased.

Basic Information on Felling Cut

Stump dimensions

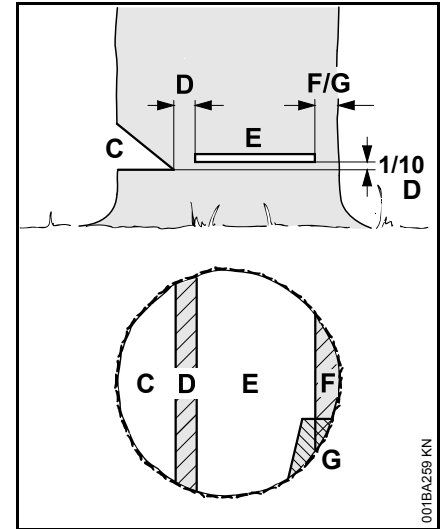

The **felling notch** (C) determines the direction of fall.

The **hinge** (D) helps control the falling tree.

- Width of hinge: about 1/10 of tree diameter.
- **To reduce the risk of accidents**, do not cut through the hinge – you could lose control of the direction of fall.
- Leave a broader hinge on rotten trees.

The tree is felled with the **felling cut** (E).

- Cut horizontally.
- 1/10 (at least 3 cm) of width of hinge (D) higher than bottom of felling notch (C).

The **holding strap** (F) or **stabilizing strap** (G) supports the tree and helps prevent it from falling prematurely.

- Width of strap: about 1/10 to 1/5 of tree diameter.
- Do not cut into the strap while making the felling cut.
- Leave a broader strap on rotten trees.

Plunge cutting

- For relieving cuts during bucking
- For wood carving

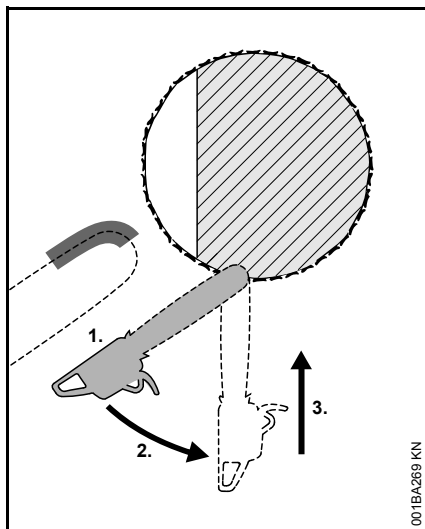

- Use a low kickback chain and exercise particular caution

1. Begin cut by applying the lower portion of the guide bar nose – do not use upper portion because of – **risk of kickback**. Start cutting at full throttle until depth of kerf is twice the width of the guide bar.
2. Swing saw slowly into plunge-cutting position – take care because of the **risk of kickback or pushback**.
3. Make the plunge cut very carefully. **Danger of pushback.**

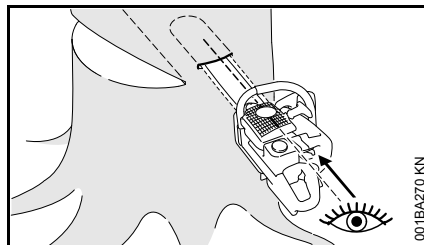

Use the plunge-cutting sight if possible. The plunge-cutting sight and the top and bottom of the guide bar are parallel.

When making the plunge cut, the sight helps keep the hinge horizontal, i.e. the same thickness all round. To do this, hold the plunge-cutting sight parallel to the chord of the felling notch.

Felling wedges

Make use of wedges as soon as possible, i.e. providing they do not interfere with cutting. Drive wedge into felling cut with a suitable tool.

Use only aluminum or plastic wedges – never steel. Steel wedges can seriously damage the saw chain and cause dangerous kickback.

Select felling wedges that suit the diameter of the tree and width of the kerf (felling cut (E)).

Contact your STIHL dealer for advice on selecting the right felling wedge (length, width and height).

Choosing Right Felling Cut

The criteria for choosing the right felling cut are the same as those for determining the direction of fall and the escape path.

There are many different variations of these characteristics. Only the two most common characteristics are described in this manual:

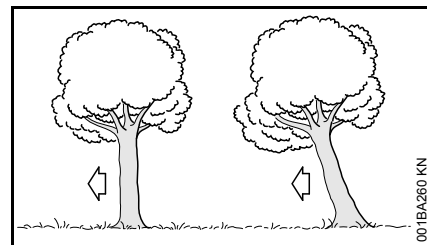

Left:	Normal tree – vertical trunk with uniform tree crown.
Right:	Leaner – tree crown leans in direction of fall.

Felling Cut with Stabilizing Strap (Normal Tree)

A) Small diameter trees

Perform this felling cut when the tree diameter is smaller than the length of the guide bar.

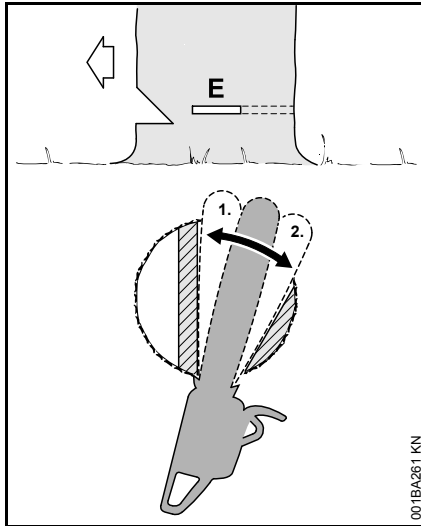

Shout a warning before starting the felling cut.

- Start felling cut (E) using plunge-cut method – insert full length of guide bar in the trunk.
- Engage the spiked bumper behind the hinge and use it as a pivot – avoid repositioning the saw more than necessary.
- Enlarge felling cut as far as hinge (1).
- Do not cut into the hinge.
- Enlarge felling cut as far as stabilizing strap (2).
- Do not cut into the stabilizing strap.

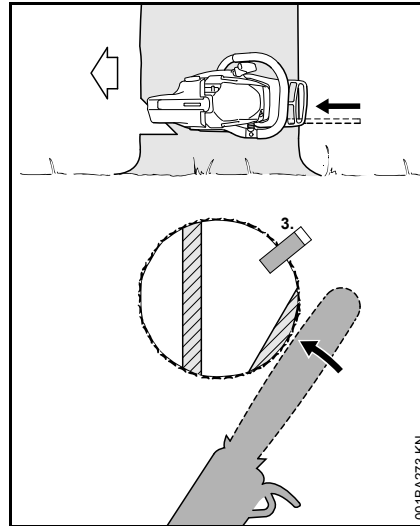

- Insert a felling wedge (3).

Shout a second warning immediately before the tree falls.

- Holding the saw with outstretched arms, cut through the stabilizing strap horizontally at the same level as the felling cut.

B) Large diameter trees

Perform this felling cut when the tree diameter is greater than the length of the guide bar.

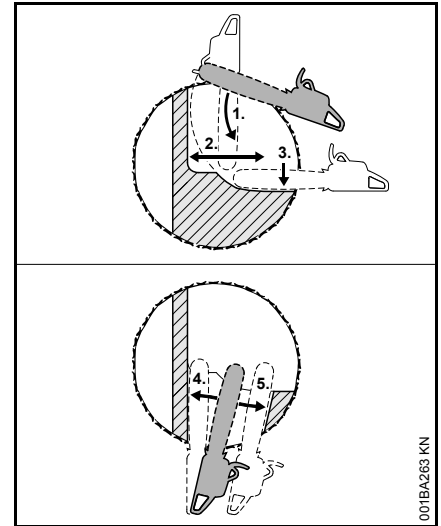

Shout a warning before starting the felling cut.

- Engage the spiked bumper at the required height of the felling cut and use it as a pivot – avoid repositioning the saw more than necessary.
- The guide bar nose enters the wood (1) before it reaches the hinge – hold the saw horizontally and swing it as far as possible.
- Enlarge felling cut as far as hinge (2).
- Do not cut into the hinge.
- Enlarge felling cut as far as stabilizing strap (3).
- Do not cut into the stabilizing strap.

Continue the felling cut on the other side of the trunk.

Make sure the second cut is at the same height as the first cut.

- Start felling cut using plunge-cut method.
- Enlarge felling cut as far as hinge (4).
- Do not cut into the hinge.
- Enlarge felling cut as far as stabilizing strap (5).
- Do not cut into the stabilizing strap.

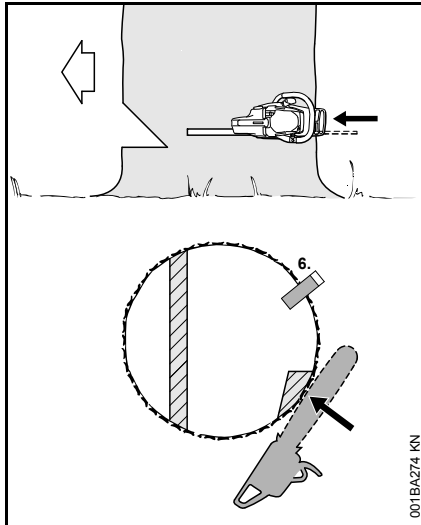

- Insert a felling wedge (6).

Shout a second warning immediately before the tree falls.

- Holding the saw with outstretched arms, cut through the stabilizing strap horizontally at the same level as the felling cut.

Felling Cut with Holding Strap (Leaner)

A) Small diameter trees

Perform this felling cut when the tree diameter is smaller than the length of the guide bar.

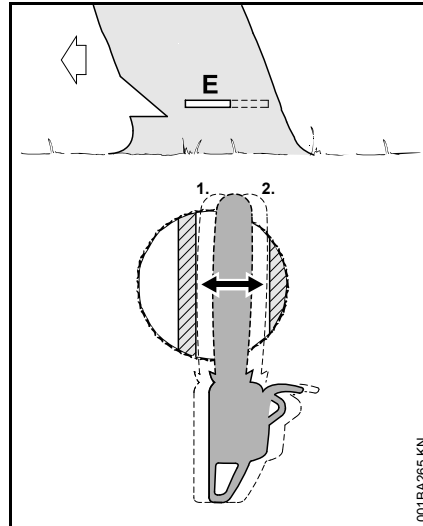

- Plunge the guide bar into the trunk until it emerges at the other side.
- Enlarge the felling cut (E) in direction of hinge (1).
- Cut horizontally.
- Do not cut into the hinge.
- Enlarge the felling cut in direction of holding strap (2).
- Cut horizontally.
- Do not cut into the holding strap.

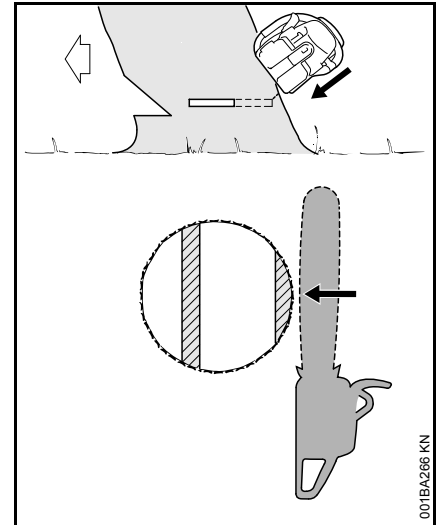

Shout a second warning immediately before the tree falls.

- Cut through the holding strap at a downward angle from outside with outstretched arms.

B) Large diameter trees

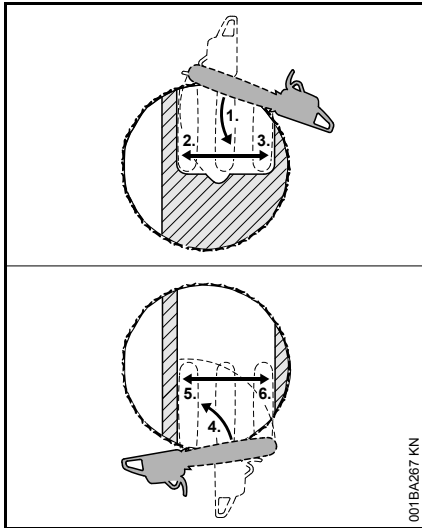

Perform this felling cut when the tree diameter is greater than the length of the guide bar.

- Engage the spiked bumper behind the holding strap and use it as a pivot – avoid repositioning the saw more than necessary.
- The guide bar nose enters the wood (1) before it reaches the hinge – hold the saw horizontally and swing it as far as possible.
- Do not cut into the holding strap or hinge.
- Enlarge felling cut as far as hinge (2).
- Do not cut into the hinge.
- Enlarge felling cut as far as holding strap (3).
- Do not cut into the holding strap.

Continue the felling cut on the other side of the trunk.

Make sure the second cut is at the same height as the first cut.

- Engage the spiked bumper behind the hinge and use it as a pivot – avoid repositioning the saw more than necessary.
- The guide bar nose enters the wood (4) before it reaches the holding strap – hold the saw horizontally and swing it as far as possible.
- Enlarge felling cut as far as hinge (5).
- Do not cut into the hinge.
- Enlarge felling cut as far as holding strap (6).
- Do not cut into the holding strap.

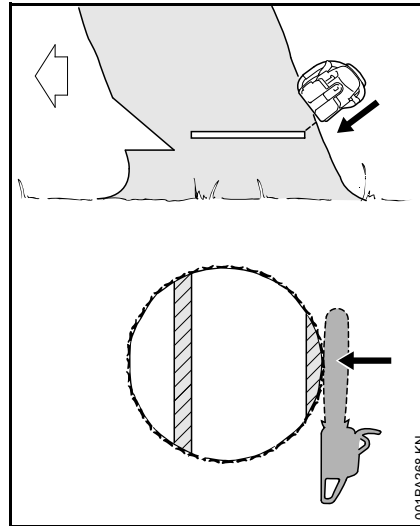

Shout a second warning immediately before the tree falls.

- Cut through the holding strap at a downward angle from outside with outstretched arms.

Cutting Attachment

A cutting attachment consists of the saw chain, guide bar and chain sprocket.

The cutting attachment that comes standard is designed to exactly match the chain saw.

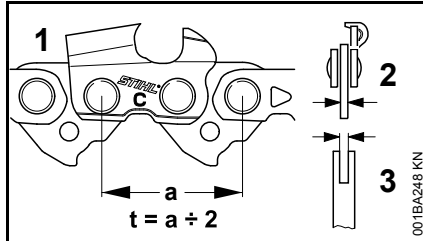

- The pitch (t) of the saw chain (1), chain sprocket and the nose sprocket of the Rollomatic guide bar must match.
- The drive link gauge (2) of the saw chain (1) must match the groove width of the guide bar (3).

If non-matching components are used, the cutting attachment may be damaged beyond repair after a short period of operation.

Chain Scabbard

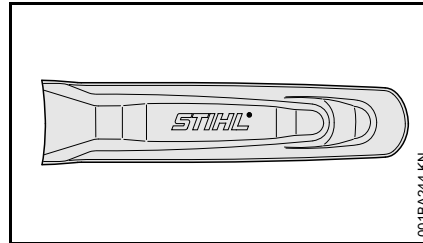

Your saw comes standard with a chain scabbard that matches the cutting attachment.

If guide bars of different lengths are mounted to the saw, always use a chain scabbard of the correct length which covers the complete guide bar.

The length of the matching guide bars is marked on the side of the chain scabbard.

Guide bars longer than 90 cm require one scabbard extension. Guide bars longer than 120 cm require two scabbard extensions.

Depending on the model, the scabbard extension either comes standard with the saw or is available as a special accessory.

Fitting Chain Scabbard Extension

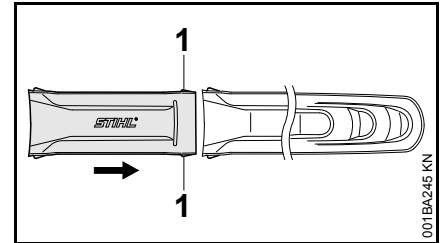

- Push the scabbard extension and chain scabbard together – the lugs (1) must engage in the chain scabbard.

Mounting the Bar and Chain

Removing the chain sprocket cover

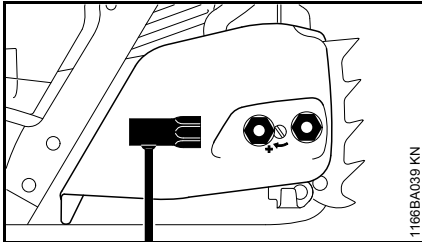

1166BA009 KN

- Turn the captive nuts to the left until it hangs loosely in the chain sprocket cover
- Remove chain sprocket cover and captive nuts

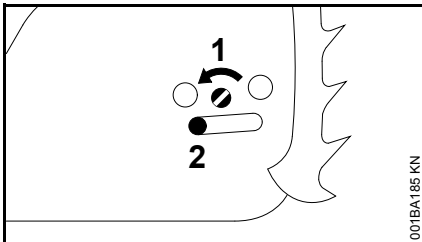

001BA185 KN

- Turn screw (1) to the left until the tensioner slide (2) butts against the left end of the housing slot

Releasing the chain brake

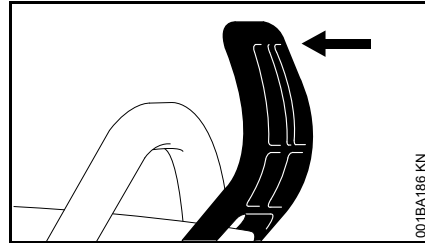

001BA186 KN

- Pull hand guard towards the front handle until it engages audibly – chain brake is released

Fitting the saw chain

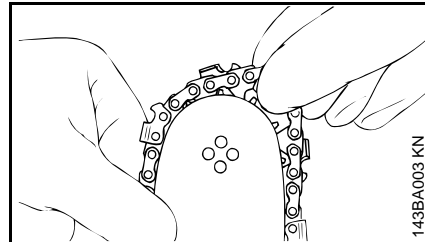

143BA003 KN

! WARNING

Put on protective gloves – risk of injury by the sharp cutters

- Fit the chain starting at the nose of the guide bar

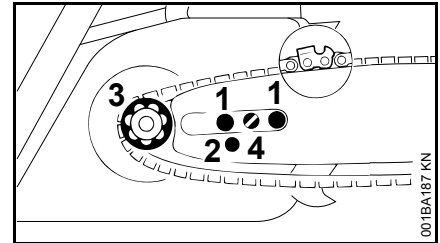

001BA187 KN

- Position the guide bar over the bolts (1) – the cutting edges of the saw chain must point to the right
- Position the locating hole (2) over the peg of the tensioner slide – simultaneously place the saw chain over the sprocket wheel (3)
- Turn screw (4) to the right until there is very little chain sag on the underside of the bar – and the drive link tangs engage in the bar groove
- Refit the chain sprocket cover – and then screw on the nut by hand until it is fingertight (only tighten the nuts after the saw chain has been tensioned)
- Go to chapter "Tensioning the saw chain"

Tensioning the Chain

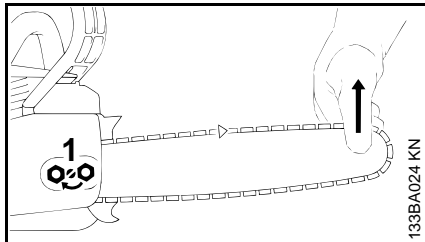

Retensioning during cutting work:

- Shut off the engine.
- Loosen the nuts.
- Hold the bar nose up.
- Use a screwdriver to turn the tensioning screw (1) clockwise until the chain fits snugly against the underside of the bar.
- While still holding the bar nose up, tighten down the nuts firmly.
- Go to "Checking Chain Tension".

A new chain has to be retensioned more often than one that has been in use for some time.

- Check chain tension frequently – see chapter on "Operating Instructions".

Checking Chain Tension

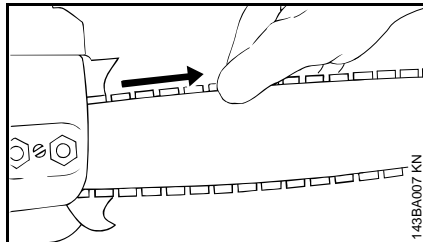

- Shut off the engine.
- Wear work gloves to protect your hands.
- The chain must fit snugly against the underside of the bar and it must still be possible to pull the chain along the bar by hand.
- If necessary, retension the chain.

A new chain has to be retensioned more often than one that has been in use for some time.

- Check chain tension frequently – see chapter on "Operating Instructions".

Fuel

Your engine requires a mixture of gasoline and engine oil.

WARNING

For health reasons, avoid direct skin contact with gasoline and avoid inhaling gasoline vapor.

STIHL MotoMix

STIHL recommends the use of STIHL MotoMix. This ready-to-use fuel mix contains no benzol or lead, has a high octane rating and ensures that you always use the right mix ratio.

STIHL MotoMix uses STIHL HP Ultra two-stroke engine oil for an extra long engine life.

MotoMix is not available in all markets.

Mixing Fuel

NOTICE

Unsuitable fuels or lubricants or mix ratios other than those specified may result in serious damage to the engine. Poor quality gasoline or engine oil may damage the engine, sealing rings, hoses and the fuel tank.

Gasoline

Use only high-quality **brand-name** gasoline with a minimum octane rating of 90 – leaded or unleaded.

Gasoline with an ethanol content of more than 10% can cause running problems in engines with a manually adjustable carburetor and should not be used in such engines.

Engines equipped with M-Tronic deliver full power when run on gasoline with an ethanol content of up to 25% (E25).

Engine Oil

If you mix the fuel yourself, use only STIHL two-stroke engine oil or another high-performance engine oil in accordance with JASO FB, JASO FC, JASO FD, ISO-L-EGB, ISO-L-EGC or ISO-L-EGD.

STIHL specifies STIHL HP Ultra two-stroke engine oil or an equivalent high-performance engine oil in order to maintain emission limits over the machine's service life.

Mix Ratio

STIHL 50:1 two-stroke engine oil: 50 parts gasoline to 1 part oil

Examples

Gasoline Liters	STIHL engine oil 50:1 Liters (ml)	
1	0.02	(20)
5	0.10	(100)
10	0.20	(200)
15	0.30	(300)
20	0.40	(400)
25	0.50	(500)

- Use a canister approved for storing fuel. Pour oil into canister first, then add gasoline and mix thoroughly.

Storing Fuel

Store fuel only in approved safety-type fuel canisters in a dry, cool and safe location protected from light and the sun.

Fuel mix ages – only mix sufficient fuel for a few weeks work. Do not store fuel mix for longer than 30 days. Exposure to light, the sun, low or high temperatures can quickly make the fuel mix unusable.

STIHL MotoMix may be stored for up to 2 years without any problems.

- Thoroughly shake the mixture in the canister before fueling your machine.

WARNING

Pressure may build up in the canister – open it carefully.

- Clean the fuel tank and canister from time to time.

Dispose of remaining fuel and cleaning fluid properly in accordance with local regulations and environmental requirements.

Fueling



Preparing the machine

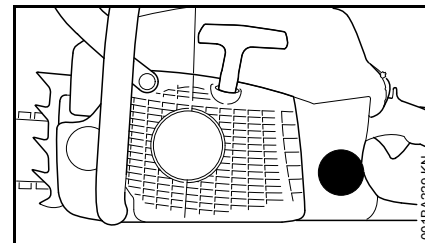

- Before fueling, clean the cap and the area around it to ensure that no dirt falls into the fuel tank
- Always position the machine so that the cap is facing upwards

Opening

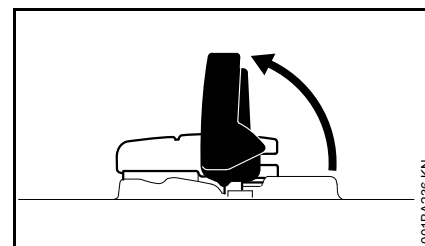

- Raise the grip until it is upright.

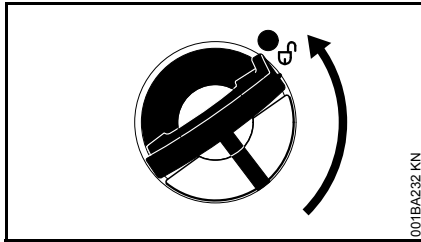

- Turn the cap counterclockwise (about a quarter turn).

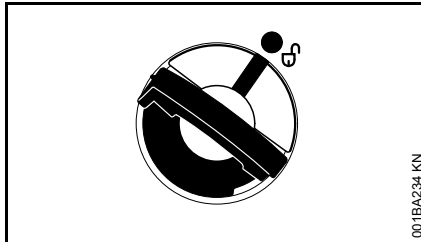

Marks on tank cap and fuel tank must line up.

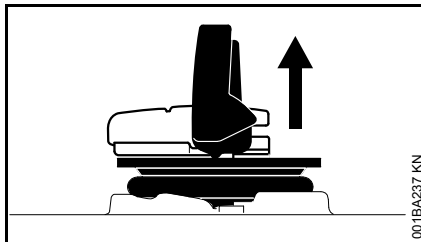

- Remove the cap.

Filling up with fuel

Take care not to spill fuel while fueling and do not overfill the tank.

STIHL recommends you use the STIHL filler nozzle for fuel (special accessory).

- Fill up with fuel.

Closing

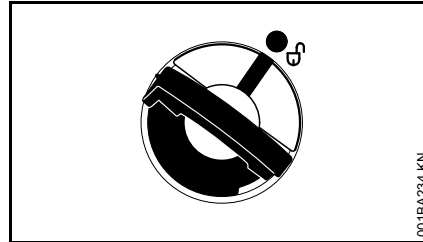

Grip must be vertical:

- Fit the cap – marks on tank cap and fuel tank must line up.
- Press the cap down as far as stop.

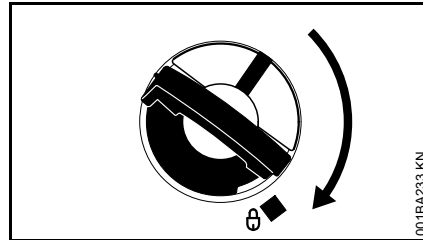

- While holding the cap depressed, turn it clockwise until it engages in position.

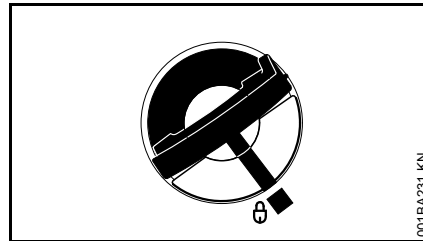

The marks on the tank cap and fuel tank are then in alignment.

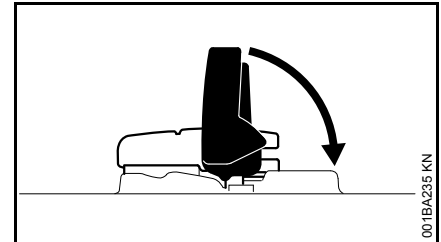

- Fold the grip down so that it is flush with the top of the cap.

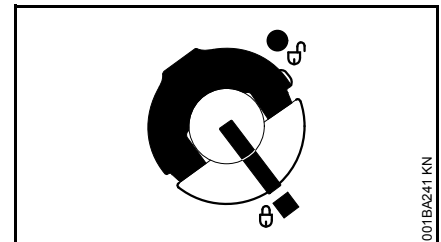

Tank cap is locked.

If the tank cap cannot be locked in the fuel tank opening

Bottom of cap is twisted in relation to top.

- Remove the cap from the fuel tank and check it from above.

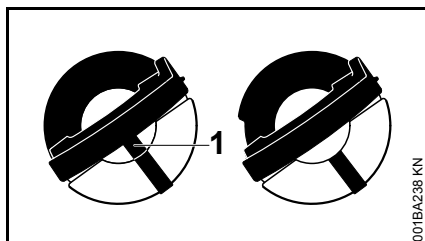

001BA238 KN

Left:	Bottom of cap is twisted – inner mark (1) in line with outer mark.
Right:	Bottom of cap in correct position – inner mark is under the grip. It is not in line with the outer mark.

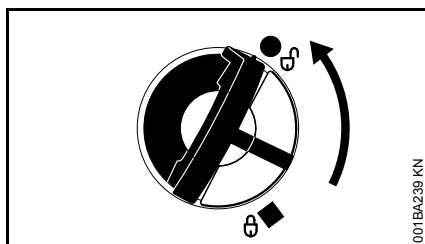

001BA239 KN

- Place the cap on the opening and rotate it counterclockwise until it engages the filler neck.
- Continue rotating the cap counterclockwise (about a quarter turn) – this causes the bottom of the cap to be turned to the correct position.
- Turn the cap clockwise and lock it in position – see section on "Closing".

Chain Lubricant

For automatic and reliable lubrication of the chain and guide bar – use only an environmentally compatible quality chain and bar lubricant. Rapidly biodegradable STIHL BioPlus is recommended.



NOTICE

Biological chain oil must be resistant to aging (e.g. STIHL BioPlus), since it will otherwise quickly turn to resin. This results in hard deposits that are difficult to remove, especially in the area of the chain drive and chain. It may even cause the oil pump to seize.

The service life of the chain and guide bar depends on the quality of the lubricant. It is therefore essential to use only a specially formulated chain lubricant.



WARNING

Do not use waste oil. Renewed contact with waste oil can cause skin cancer. Moreover, waste oil is environmentally harmful.



NOTICE

Waste oil does not have the necessary lubricating properties and is unsuitable for chain lubrication.

Filling Chain Oil Tank



Preparing the machine

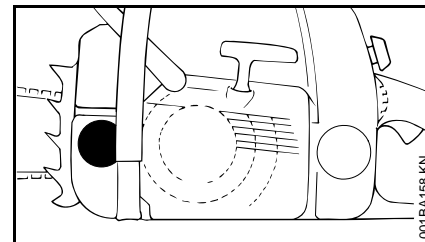

001BA158 KN

- Thoroughly clean the filler cap and the area around it to ensure that no dirt falls into the tank
- Always position the machine so that the filler cap is facing upwards
- Open the filler cap

Filling chain oil tank

Standard oil pump setting

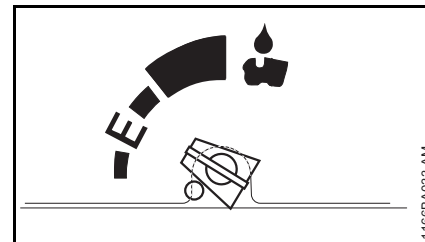

1166BA033 AM

- Refill the chain oil tank every time you refuel

Oil pump setting for increased oil delivery rate

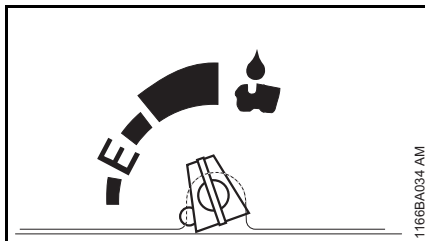

Frequent checking and refilling of the oil tank is necessary – see "Adjusting oil quantity".

- Refill the chain oil tank when the fuel tank is approximately half empty

All oil pump settings

Take care not to spill chain oil during refilling and do not overfill the tank.

STIHL recommends use of the STIHL filling system for chain oil (special accessory).

- Close filler cap

There must still be a small amount of chain oil in the oil tank when the fuel tank is empty.

If the oil tank is still partly full, the reason may be a problem in the oil supply system: Check chain lubrication, clean the oil passages, contact your servicing dealer for assistance if necessary.

STIHL recommends that maintenance and repair work be carried out only by authorised STIHL dealers.

Checking Chain Lubrication

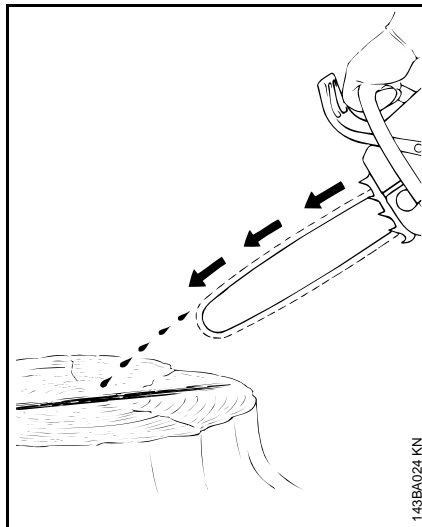

The saw chain must always throw off a small amount of oil.

NOTICE

Never operate your saw without chain lubrication. If the chain runs dry, the whole cutting attachment will be irretrievably damaged within a very short time. Always check chain lubrication and the oil level in the tank before starting work.

Every new chain has to be broken in for about 2 to 3 minutes.

After breaking in the chain, check chain tension and adjust if necessary – see "Checking Chain Tension".

Chain Brake



Locking the chain

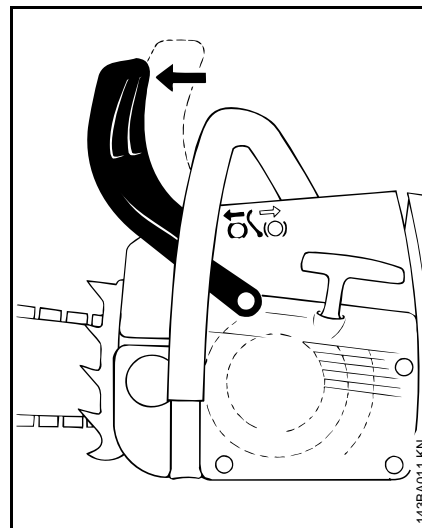

- in an emergency
- when starting
- at idling speed

The chain brake is activated by pushing the hand guard toward the bar nose with your left hand – or by inertia in certain kickback situations: The chain is stopped and locked.

Releasing the chain brake

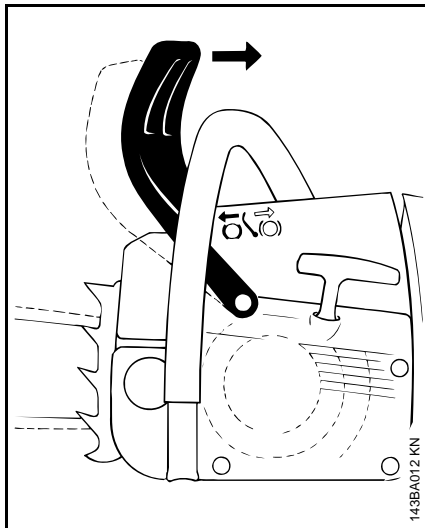

- Pull the hand guard back toward the front handle,

NOTICE

Always disengage chain brake before accelerating the engine (except when checking its operation) and before starting cutting work.

High revs with the chain brake engaged (chain locked) will quickly damage the powerhead and chain drive (clutch, chain brake).

The chain brake is also activated by the inertia of the front hand guard if the kickback force of the saw is high enough: The hand guard is accelerated toward the bar nose – even if your left hand is not behind the hand guard, e.g. during felling cut.

The chain brake will operate only if the hand guard has not been modified in any way.

Check operation of the chain brake

Before starting work: Run engine at idle speed, engage the chain brake (push hand guard toward bar nose) and open the throttle wide for no more than 3 seconds – the chain must not rotate. The hand guard must be free from dirt and move freely.

Chain brake maintenance

The chain brake is subject to normal wear. It is necessary to have it serviced and maintained regularly by trained personnel. STIHL recommends that you have servicing and repair work carried out exclusively by an authorized STIHL servicing dealer. Maintain the following servicing intervals:

Full-time usage:	every 3 months
Part-time usage:	every 6 months
Occasional usage:	every 12 months

Winter Operation



Pre-heat carburetor at temperatures below +10 °C

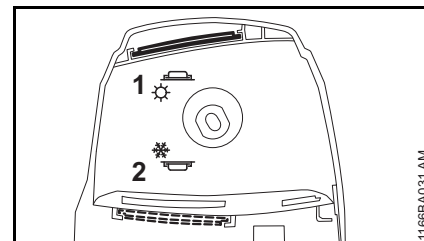

- Remove the filter cover.
- in the filter cover, move the slide (1) from summer position to winter position (2)

Heated air is now drawn in from around the cylinder and mixed with cold air – this helps prevent carburetor icing.

- At temperatures **above +20 °C**: always return the slide to the summer position –

NOTICE

otherwise risk of engine malfunction due to overheating!

If engine trouble occurs, first return the slide from winter to summer position.

At temperatures below -10 °C

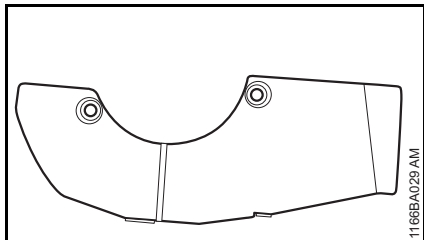

Under extreme winter conditions (temperatures below -10 °C, powdered or drifting snow), it is recommended to mount the cover plate (special accessory) on the fan housing.

The partial covering of the slits in the fan housing keeps out powdered or drifting snow.

- If the chain saw is extremely cold (frost formation) – after starting, bring the engine up to operating temperature at medium speed (disengage chain brake!)

Mounting the cover plate (special accessory)

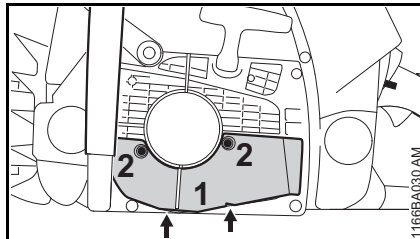

- Insert cover plate (1) with both tabs (arrows) and snap it onto the fan housing
- Screw in screws (2)

When the mounting kit is used, the slide must be in the winter position.

If engine trouble occurs, first check whether use of the cover plate is necessary.

Electric Handle Heating



Switching on the handle heating system (depending on equipment version)

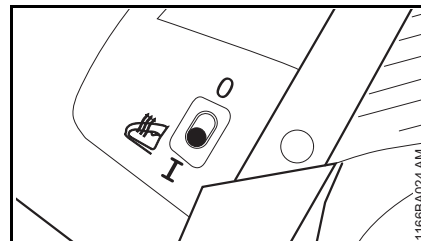

- Set switch to **I** – to switch off, return switch to the **0** position

Overheating during continuous use is impossible. The heating system is maintenance-free.

Starting / Stopping the Engine

Positions of Master Control Lever

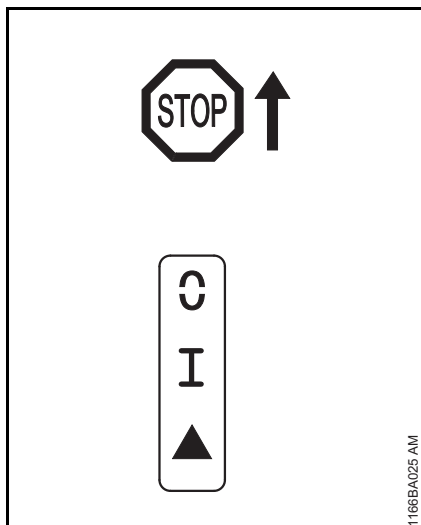

STOP or ◯ – Master Control lever must be pushed in direction of **STOP** or ◯ to switch off ignition. The Master Control lever springs back to the run position **I** when it is released.

WARNING

The ignition is switched on again automatically after the engine stops. Engine can be started by operating the rewind starter.

Run position I – a hot engine is started in this position or the engine runs in this position.

Start position ▲ – a cold engine is started in this position.

Setting the Master Control Lever

To move the Master Control lever from the run position **I** to start **▲**, depress the trigger lockout and the throttle trigger and hold them in that position – set the Master Control lever to start **▲** and let go of the throttle trigger and trigger lockout.

The Master Control lever moves from the start position (**▲**) to the run position (**I**) when you press down the throttle trigger lockout and squeeze the throttle trigger at the same time.

To switch off the engine, move the Master Control lever in the direction of **STOP** or ◯ – when released, the Master Control lever springs back to the run position **I**.

Holding the Saw

There are two ways of holding the saw when starting.

On the ground

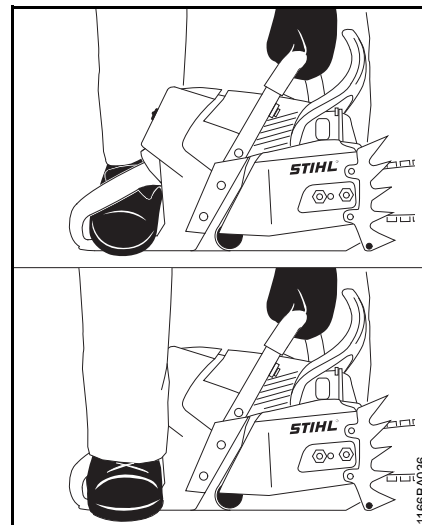

- Place your saw on the ground. Make sure you have a firm footing – check that the chain is not touching any object or the ground.
- Hold the saw firmly on the ground with your left hand on the front handle – your thumb should be under the handle.
- Put your right foot into the rear handle or your right heel on the rear hand guard and press down.

Between knees or thighs

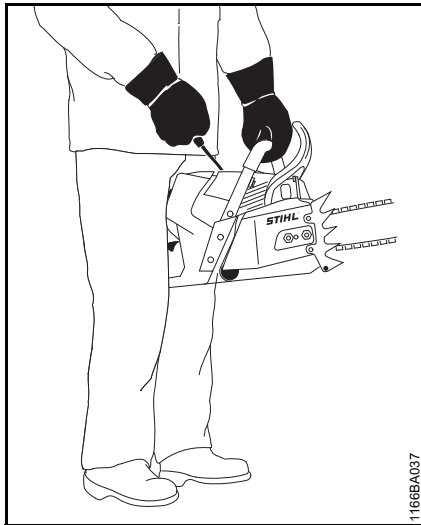

- Hold the rear handle tightly between your legs, just above the knees.
- Hold the front handle firmly with your left hand – your thumb should be under the handle.

Cranking

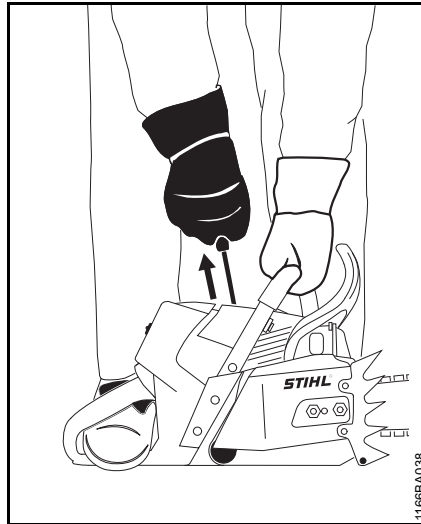

- Pull the starter grip slowly with your right hand until you feel it engage – and then give it a brisk strong pull and push down the front handle at the same time. Do not pull out the starter rope to full length – **it might otherwise break**. Do not let the starter grip snap back. Guide it slowly back into the housing so that the starter rope can rewind properly.

Machines without additional manual fuel pump: If the engine is new or after a long out-of-service period or if the tank has been run dry (engine stops), it may be necessary to pull the starter rope several times to prime the fuel system.

Starting the Saw

Decompression valve

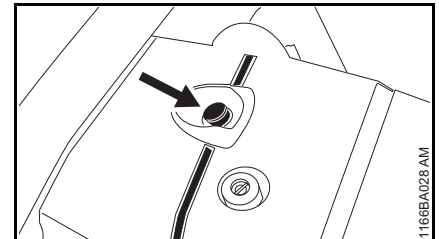

- Press in the button to open the decompression valve.

The decompression valve closes as soon as the engine fires. For this reason you must press in the button before each starting attempt.

WARNING

Bystanders must be well clear of the general work area of the saw.

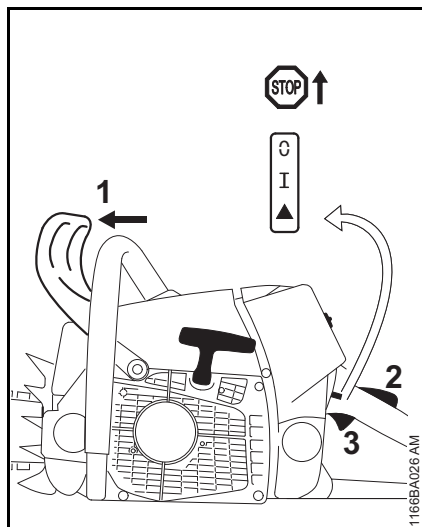

- Push the hand guard (1) forward – the chain is locked.

The Master Control lever is in the normal run position **I**.

- If the engine is cold: Press down the trigger lockout (2) and pull the throttle trigger (3) at the same time. Hold both levers in that position and set the Master Control lever to start symbol **▲**.
- Hold your saw firmly.
- Pull the starter grip quickly and firmly as often as necessary until the engine starts.
- If the engine does not start: Move the Master Control lever to start position **▲** and repeat starting procedure.

As soon as the engine runs

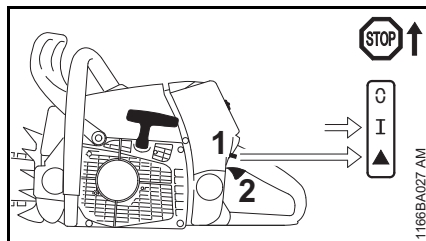

- If the engine was started in the start position **▲**: Press down trigger lockout and pull the throttle trigger (2) at the same time – the Master Control lever (1) moves to the run position (**I**) and the engine settles down to idling speed.

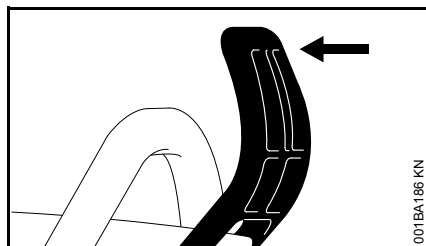

- Pull the hand guard back towards the front handle.

The chain brake is now disengaged – your saw is ready for operation.

NOTICE

Always disengage chain brake before accelerating the engine. High revs with the chain brake engaged (chain locked) will quickly damage the clutch and chain brake.

At very low outside temperatures

- Change over to winter operation if necessary – see “Winter Operation”.

Stopping the Engine

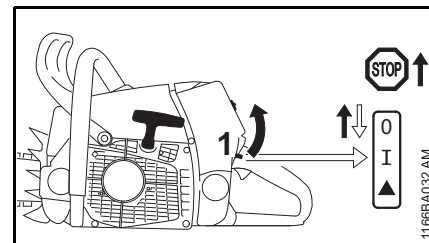

- Move the Master Control lever in the direction of **STOP** or **O** – when released, the Master Control lever springs back to the normal run position **I**.

If engine does not start

- Check that all settings are correct.
- Check that there is fuel in the tank and refuel if necessary.
- Check that the spark plug boot is properly connected.
- Repeat the starting procedure.

or:

It is possible that the fuel-air mixture in the combustion chamber is over-rich and has flooded the engine.

- Remove the spark plug – see “Spark Plug”.
- Dry the spark plug.

- Hold the saw on the ground.
- Push the Master Control lever as far as stop in direction of **STOP** or  and hold it there.

WARNING

An ignition spark may occur if the Master Control lever is not held against **STOP** or .

- Operate the rewind starter several times.
- Release the Master Control lever – it springs back to the run position **I**.
- Install the spark plug – see "Spark Plug".
- Hold and start your saw as described.

Operating Instructions

During the break-in period

A factory new machine should not be run at high revs (full throttle off load) for the first three tank fillings. This avoids unnecessarily high loads during the break-in period. As all moving parts have to bed in during the break-in period, the frictional resistances in the shortblock are greater during this period. The engine develops its maximum power after about 5 to 15 tank fillings.

During work

NOTICE

Open the throttle only when the chain brake is off. Running the engine at high revs with the chain brake engaged (chain locked) will quickly damage the engine and chain drive (clutch, chain brake).

Check chain tension frequently

A new saw chain must be retensioned more frequently than one that has been in use already for an extended period.

Chain cold

Tension is correct when the chain fits snugly against the underside of the bar but can still be pulled along the bar by hand. Retension if necessary – see "Tensioning the Saw Chain".

Chain at operating temperature

The chain stretches and begins to sag. The drive links must not come out of the bar groove on the underside of the bar – the chain may otherwise jump off the bar. Retension the chain – see "Tensioning the Saw Chain".

NOTICE

The chain contracts as it cools down. If it is not slackened off, it can damage the crankshaft and bearings.

After a long period of full-throttle operation

After a long period of full-throttle operation, allow engine to run for a while at idle speed so that the heat in the engine can be dissipated by flow of cooling air. This protects engine-mounted components (ignition, carburetor) from thermal overload.

After finishing work

- Slacken off the chain if you have retensioned it at operating temperature during work.

NOTICE

Always slacken off the chain again after finishing work. The chain contracts as it cools down. If it is not slackened off, it can damage the crankshaft and bearings.

Short-term storage

Wait for engine to cool down. Keep the machine with a full tank of fuel in a dry place, well away from sources of ignition, until you need it again.

Long-term storage

See "Storing the machine"

Oil Quantity Control



Varying cutting lengths, types of wood and work techniques require varying amounts of oil.

Standard setting

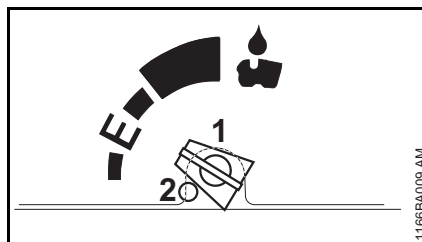

The oil flow can be adjusted as needed using the adjusting screw (1) (on the bottom of the machine).

Ematic position (E), medium oil flow –

- Turn adjusting screw to "E" (Ematic position)

To increase oil flow –

- Turn the adjusting screw clockwise – adjusting screw is limited by end stop (2)

To reduce oil flow –

- turn the adjusting screw counterclockwise



NOTICE

The saw chain must always be coated with oil.

Setting for increased oil delivery rate

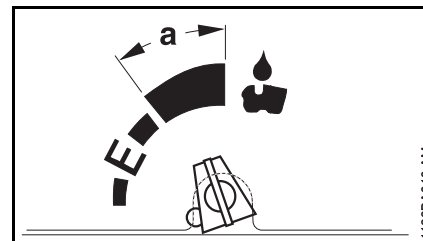

If necessary, the oil flow can be increased beyond the standard setting.

- Press in end stop (2) using a suitable tool – end stop is no longer functional, the oil flow can be increased further

If the end stop has been pressed in, it remains in this position.

To increase oil flow –

- turn the adjusting screw clockwise

To reduce oil flow –

- turn the adjusting screw counterclockwise

In adjustment range **a**, the oil tank may run dry before the fuel tank, thus resulting in the saw chain running dry.

- In adjustment range **a**, fill the fuel tank only half full or refill the oil tank when the fuel tank is approximately half empty



NOTICE

If an increased oil flow is no longer required, reset the adjusting screw to the standard setting.

Taking Care of the Guide Bar

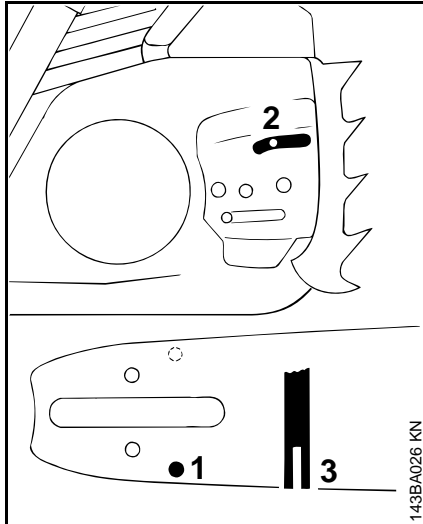

- Flip the bar – after each sharpening and each time the chain is changed – to avoid uneven wear, especially at the sprocket nose and on the bottom
- Periodically clean the oil inlet hole (1), oil outlet channel (2) and bar groove (3)
- Measure groove depth – using the measuring tool on the file gauge (special accessory) – in the area with the greatest wear

Chain type	Chain pitch	Minimum groove depth
Picco	1/4" P	4.0 mm
Rapid	1/4"	4.0 mm

Picco	3/8" P	5.0 mm
Rapid	3/8"; 0.325"	6.0 mm
Rapid	0.404"	7.0 mm

If the groove is not at least this deep:

- Replace guide bar

Otherwise the drive links will grind against the base of the groove – the bottoms of the cutters and the tie straps will not lie against the bar.

Remove Air Filter

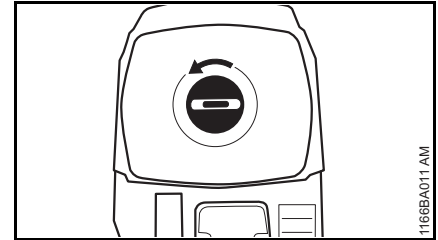

- Turn the knob above the rear handle in the direction of the arrow and remove the carburetor box cover

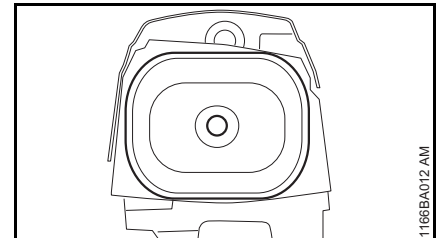

- Remove filter

Cleaning the Air Filter

If there is a noticeable loss of engine power:

- Wash the filter in STIHL special-purpose cleaner (special accessory) or a clean, non-flammable cleaning liquid (e.g., warm soapy water) – rinse the filter from inside to out under a water jet – do not use high-pressure cleaners
- Dry all filter parts – do not expose to extreme heat
- Do not oil the filter
- Reinstall filter

M-Tronic

During operation the chain saw automatically adjusts to the optimum power.

Depending on the STIHL M-Tronic version the chain saw can be adjusted more quickly to the optimum power in two different ways:

- “Speeding up automatic adaptation of the chain saw”
- “Calibrating the chain saw”

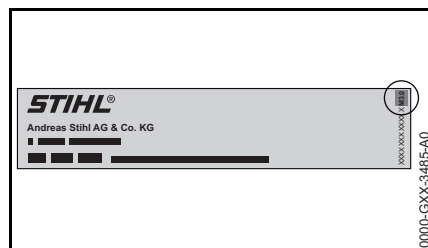

The STIHL M-Tronic version is indicated on the approval label of the chain saw, e.g. "M3.0" indicates the STIHL M-Tronic version 3.0.

- If the STIHL M-Tronic version is lower than 3.0: “Speeding up automatic adaptation of the chain saw”.
- If the STIHL M-Tronic version is 3.0 or higher: “Calibrating the chain saw”.

Speeding Up Automatic Adaptation of the Chain Saw

- Carry out five uniform cuts to length at full throttle.

Calibrating the Chain Saw

If the external temperature is below -10°C or the engine is cold:

- Start engine and release chain brake.
- Warm up engine for about 1 minute by blipping the throttle.
- Switch off engine.

To calibrate the chain saw, carry out the following steps:

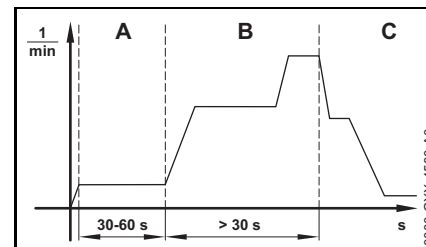

- Set master control lever to ▲ position.
- Engage chain brake.
- Start engine without depressing the throttle trigger. The engine runs and the master control lever remains in the ▲ position.
- Allow engine to run for at least 30 to max. 60 seconds (A) without depressing the throttle trigger.

! WARNING

The saw chain may rotate when the chain brake is released - **risk of injury!**

Hold the chain saw as described in the Instruction Manual and do not touch the moving saw chain.

- Release chain brake.



NOTICE

If the throttle trigger is released before the chain saw has been fully calibrated, calibration will be aborted. Calibration has to be started again from the beginning.

- Fully depress throttle trigger and hold it there.



NOTICE

If the throttle trigger is not fully depressed during calibration, the chain saw may not adjust correctly. The chain saw may be damaged.

- Fully depress throttle trigger and hold it there.
- Depress and hold down throttle trigger for at least 30 seconds (B).

The engine accelerates and the saw chain rotates. The chain saw is being calibrated. The engine speed fluctuates and increases perceptibly during calibration.

If the engine stops:

- try again to calibrate the chain saw.

If the engine repeatedly stops:

- Engage chain brake.
- Do not use the chain saw. Consult a STIHL servicing dealer. The chain saw has a fault.

As soon as the engine speed audibly and perceptibly drops (C):

- Release throttle trigger.

The engine idles. The chain saw is calibrated and ready for use.

Spark Arresting Screen in Muffler

- If engine performance deteriorates, check the spark arresting screen in the muffler
- Let the muffler cool down

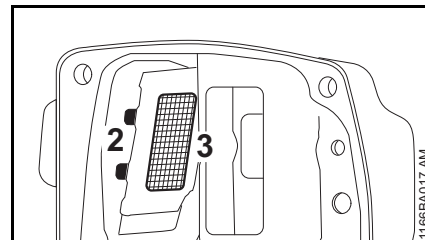
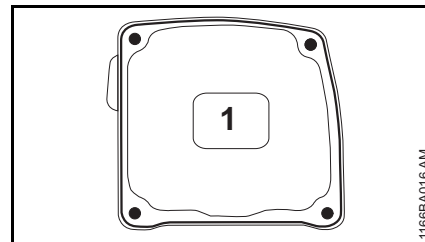

- Remove four screws
- Remove exhaust casing (1) of the muffler
- Bend back the retaining lugs (2)
- Pull out spark arresting screen (3)
- Clean the dirty spark arresting screen, replace if damaged or heavily carbonised
- Refit the spark arresting screen in reverse order of steps

Spark Plug

- If the engine is down on power, difficult to start or runs poorly at idle speed, first check the spark plug.
- Fit a new spark plug after about 100 operating hours – or sooner if the electrodes are badly eroded. Install only suppressed spark plugs of the type approved by STIHL – see "Specifications".

Removing the spark plug

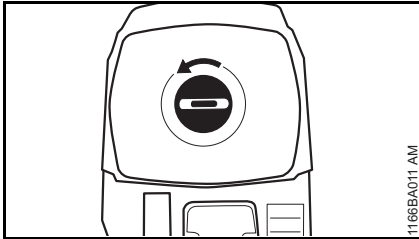

- Turn the cap above the rear handle in the direction of the arrow and remove the filter cover

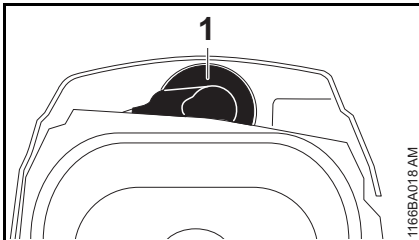

- Unplug spark plug boot (1)
- Unscrew spark plug

Checking the Spark Plug

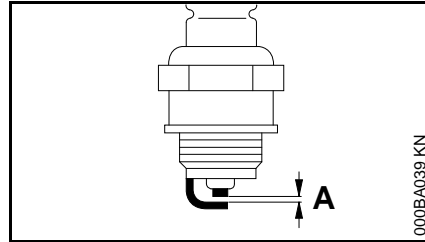

- Clean dirty spark plug.
- Check electrode gap (A) and readjust if necessary – see "Specifications".
- Rectify the problems which have caused fouling of the spark plug.

Possible causes are:

- Too much oil in fuel mix.
- Dirty air filter.
- Unfavorable running conditions.

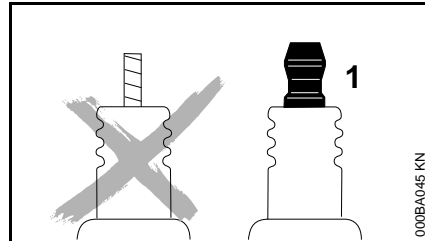

! WARNING

Arcing may occur if the adapter nut (1) is loose or missing. Working in an easily combustible or explosive atmosphere may cause a fire or an explosion. This can result in serious injuries or damage to property.

- Use resistor type spark plugs with a properly tightened adapter nut.

Installing the spark plug

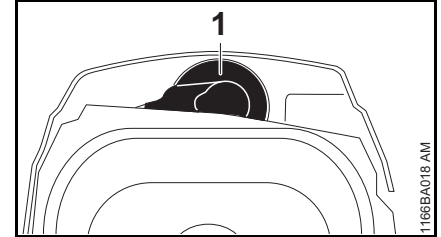

- Screw in the spark plug
- Press on the spark plug boot (1) firmly
- Mount filter cover

Storing the Machine

For periods of 3 months or longer

- Drain and clean the fuel tank in a well ventilated area.
- Dispose of fuel properly in accordance with local environmental requirements.
- Run the engine until the carburetor is dry – this helps prevent the carburetor diaphragms sticking together.
- Remove the saw chain and guide bar, clean them and spray with corrosion inhibiting oil.
- Thoroughly clean the machine – pay special attention to the cylinder fins and air filter.
- If you use a biological chain and bar lubricant, e.g. STIHL BioPlus, completely fill the chain oil tank.
- Store the machine in a dry, high or locked location, out of the reach of children and other unauthorized persons.

Checking and Replacing the Chain Sprocket

- Remove chain sprocket cover, saw chain and guide bar.
- Release chain brake – pull hand guard against the front handle

Fit new chain sprocket

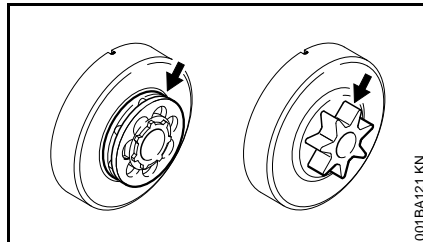

- after use of two saw chains or earlier
- if the wear marks (arrows) are deeper than 0.5 mm – otherwise the service life of the saw chain is reduced – use check gauge (special accessory) to test

Using two saw chains in alternation helps preserve the chain sprocket.

STIHL recommends use of original STIHL chain sprockets in order to ensure optimal functioning of the chain brake.

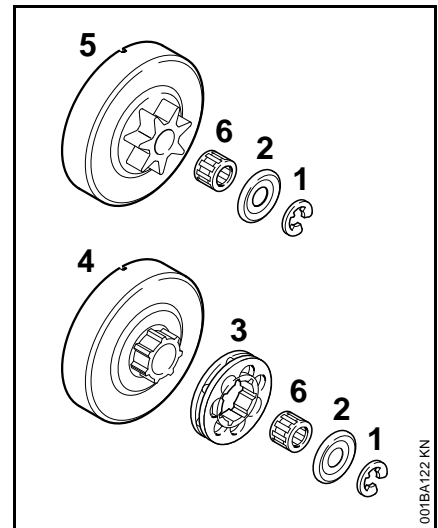

- Use a screwdriver to remove the E-clip (1)
- Remove the washer (2)
- Remove rim sprocket (3)
- Inspect transport profile on the clutch drum (4) – if there are also heavy signs of wear, also replace the clutch drum
- Remove clutch drum or spur chain sprocket (5) including needle cage (6) from the crankshaft – with QuickStop Super chain brake, press throttle trigger lockout beforehand

Install spur chain sprocket / rim sprocket

- Clean crankshaft stub and needle cage and lubricate with STIHL lubricant (special accessory)
- Slide needle cage onto the crankshaft stub

- After refitting, turn the clutch drum and/or spur chain sprocket approx. 1 full turn so that the carrier for the oil pump drive engages – with QuickStop Super chain brake, press throttle trigger lockout beforehand
- Refit the rim sprocket – cavities toward the outside
- Refit washer and E-clip on the crankshaft

Maintaining and Sharpening the Saw Chain

Sawing effortlessly with a properly sharpened saw chain

A properly sharpened saw chain cuts through wood effortlessly even with very little pushing.

Never use a dull or damaged saw chain – this leads to increased physical strain, increased vibration load, unsatisfactory cutting results and increased wear.

- Clean the saw chain
- Check the saw chain for cracks and damaged rivets
- Replace damaged or worn chain components and adapt these parts to the remaining parts in terms of shape and level of wear – rework accordingly

Carbide-tipped (Duro) saw chains are especially wear-resistant. For an optimal sharpening result, STIHL recommends STIHL servicing dealers.

WARNING

Compliance with the angles and dimensions listed below is absolutely necessary. An improperly sharpened saw chain – especially depth gauges that are too low – can lead to increased kickback tendency of the chain saw – **risk of injury!**

Chain pitch

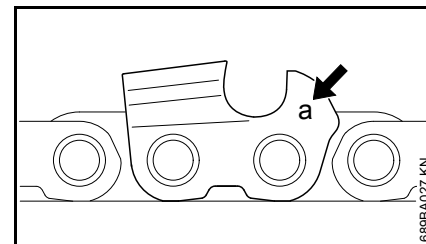

The chain pitch marking (**a**) is embossed in the area of the depth gauge of each cutter.

Marking (a)	Chain pitch	
	Inches	mm
7	1/4 P	6.35
1 or 1/4	1/4	6.35
6, P or PM	3/8 P	9.32
2 or 325	0.325	8.25
3 or 3/8	3/8	9.32
4 or 404	0.404	10.26

The diameter of file to be used depends on the chain pitch – see table "Sharpening tools".

The angles of the cutter must be maintained during reshaping.

Sharpening and side plate angles

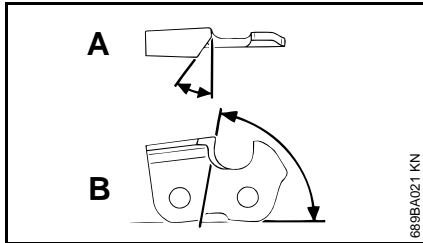

A Sharpening angle

STIHL saw chains are sharpened with a 30° sharpening angle. Ripping chains, which are sharpened with a 10° sharpening angle, are exceptions. Ripping chains have an X in the designation.

B Side plate angle

The correct side plate angle results automatically when the specified file holder and file diameter are used.

Tooth shapes	Angle (°)	
	A	B
Micro = semi-chisel tooth, e. g., 63 PM3, 26 RM3, 36 RM	30	75
Super = full chisel tooth, e. g., 63 PS3, 26 RS, 36 RS3	30	60
Ripping chain, e. g., 63 PMX, 36 RMX	10	75

The angles must be identical for all cutters in the saw chain. Varying angles: Rough, uneven running of the saw chain, increased wear – even to the point of saw chain breakage.

File holder

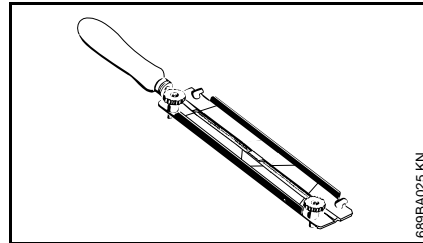

● Use a file holder

Always use a file holder (special accessory, see table "Sharpening tools") when sharpening saw chains by hand. File holders have markings for the sharpening angle.

Use only special saw chain files! Other files are unsuitable in terms of shape and type of cutting.

To check the angles

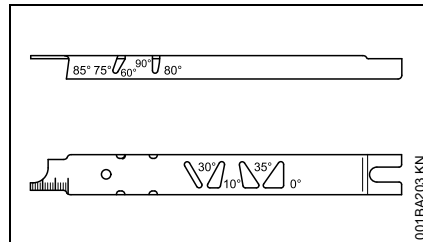

STIHL filing gauge (special accessory, see table "Sharpening tools") – a universal tool for checking sharpening and side plate angles, depth gauge setting, and tooth length, as well as cleaning grooves and oil inlet holes.

Proper sharpening

- Select sharpening tools in accordance with chain pitch
- Clamp guide bar if necessary
- Block saw chain – push the hand guard forward
- To advance the saw chain, pull the hand guard toward the handlebar: The chain brake is disengaged. With the Quickstop Super chain brake system, additionally press the throttle trigger lockout
- Sharpen frequently, removing little material – two or three strokes of the file are usually sufficient for simple resharping

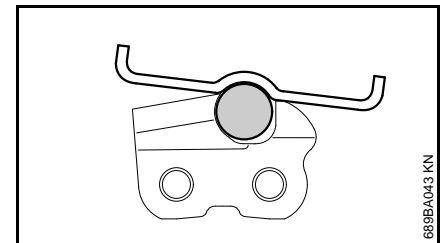
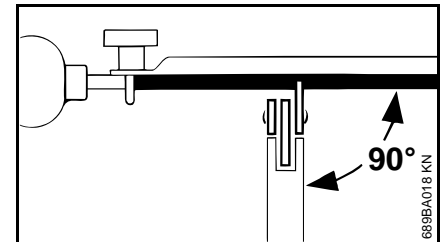

- Guide the file: **horizontally** (at a right angle to the side surface of the guide bar) in accordance with the specified angle – according to the

markings on the file holder – rest the file holder on the tooth head and the depth gauge

- File only from the inside outward
- The file only sharpens on the forward stroke – lift the file on the backstroke
- Do not file tie straps and drive links
- Rotate the file a little periodically in order to avoid uneven wear
- To remove file burr, use a piece of hardwood
- Check angle with file gauge

All cutters must be equally long.

With varying cutter lengths, the cutter heights also vary and cause rough running of the saw chain and chain breakage.

- All cutters must be filed down equal to the length of the shortest cutter – ideally, one should have this done by a servicing dealer using an electric sharpener

Depth gauge setting

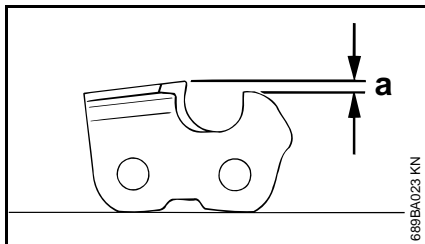

The depth gauge determines the depth to which the cutter penetrates the wood and thus the chip thickness.

- a** Required distance between depth gauge and cutting edge

When cutting softwood outside of the frost season, the distance can be increased by up to 0.2 mm (0.008").

Chain pitch		Depth gauge Distance (a)	
Inches	(mm)	mm	(Inches)
1/4 P	(6.35)	0.45	(0.018)
1/4	(6.35)	0.65	(0.026)
3/8 P	(9.32)	0.65	(0.026)
0.325	(8.25)	0.65	(0.026)
3/8	(9.32)	0.65	(0.026)
0.404	(10.26)	0.80	(0.031)

Lowering the depth gauges

The depth gauge setting is lowered when the cutter is sharpened.

- Check the depth gauge setting after each sharpening

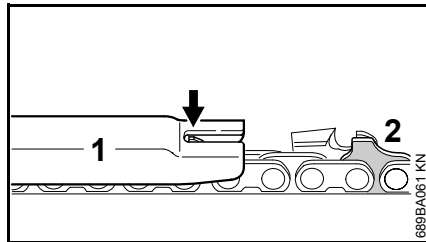

- Lay the appropriate file gauge (1) for the chain pitch on the saw chain and press it against the cutter to be checked – if the depth gauge protrudes past the file gauge, the depth gauge must be reworked

Saw chains with humped drive link (2) – upper part of the humped drive link (2) (with service mark) is lowered at the same time as the depth gauge of the cutter.



WARNING

The rest of the humped drive link must not be filed; otherwise, this could increase the tendency of the chain saw to kick back.

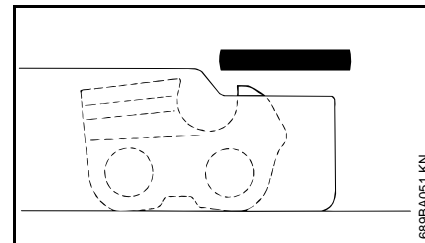

- Rework the depth gauge so that it is flush with the file gauge

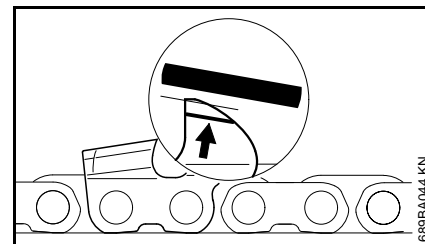

- Afterwards, dress the leading edge of the depth gauge parallel to the service mark (see arrow) – when doing this, be careful not to further lower the highest point of the depth gauge

WARNING

Depth gauges that are too low increase the kickback tendency of the chain saw.

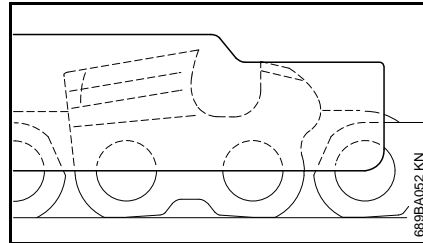

- Lay the file gauge on the saw chain – the highest point of the depth gauge must be flush with the file gauge

- After sharpening, clean the saw chain thoroughly, removing any filings or grinding dust – lubricate the saw chain thoroughly
- In the event of extended periods of disuse, store saw chains in cleaned and oiled condition

Sharpening tools (special accessories)

Chain pitch		Round file Ø		Round file	File holder	File gauge	Taper square file	Sharpening set ¹⁾
Inches	(mm)	mm	(Inches)	Part number	Part number	Part number	Part number	Part number
1/4P	(6.35)	3.2	(1/8)	5605 771 3206	5605 750 4300	0000 893 4005	0814 252 3356	5605 007 1000
1/4	(6.35)	4.0	(5/32)	5605 772 4006	5605 750 4327	1110 893 4000	0814 252 3356	5605 007 1027
3/8 P	(9.32)	4.0	(5/32)	5605 772 4006	5605 750 4327	1110 893 4000	0814 252 3356	5605 007 1027
0.325	(8.25)	4.8	(3/16)	5605 772 4806	5605 750 4328	1110 893 4000	0814 252 3356	5605 007 1028
3/8	(9.32)	5.2	(13/64)	5605 772 5206	5605 750 4329	1110 893 4000	0814 252 3356	5605 007 1029
0.404	(10.26)	5.5	(7/32)	5605 772 5506	5605 750 4330	1106 893 4000	0814 252 3356	5605 007 1030

¹⁾ consisting of file holder with round file, taper square file and file gauge

Maintenance and Care

The following information applies in normal operating conditions. The specified intervals must be shortened accordingly when working for longer than normal or under difficult cutting conditions (extensive dust, highly resinous lumber, lumber from tropical trees, etc.). If the machine is only used occasionally, the intervals can be extended accordingly.		Before starting work	At the end of work and/or daily	Whenever tank is refilled	Weekly	Monthly	Yearly	If faulty	If damaged	As required
Complete machine	Visual inspection (condition, leaks)	X		X						
	Clean		X							
Throttle trigger, throttle trigger lockout, choke lever, choke control, stop switch, master control lever (dependent on equipment)	Function tests	X		X						
Chain brake	Function tests	X		X						
	Have checked by a specialist dealer ¹⁾									X
Manual fuel pump (if present)	Check	X								
	Have repaired by a specialist dealer ¹⁾								X	
Fuel pick-up body / filter in fuel tank	Check					X				
	Clean, replace filter insert					X		X		
	Replace						X		X	X
Fuel tank	Clean					X				
Lubricating oil tank	Clean					X				
Chain lubrication	Check	X								
Saw chain	Check, pay attention to sharpness	X		X						
	Check chain tension	X		X						
	Sharpen									X
Guide bar	Check (wear, damage)	X								
	Clean and turn over									X
	Deburr				X					
	Replace								X	X
Chain sprocket	Check				X					

The following information applies in normal operating conditions. The specified intervals must be shortened accordingly when working for longer than normal or under difficult cutting conditions (extensive dust, highly resinous lumber, lumber from tropical trees, etc.). If the machine is only used occasionally, the intervals can be extended accordingly.		Before starting work	At the end of work and/or daily	Whenever tank is refilled	Weekly	Monthly	Yearly	If faulty	If damaged	As required
Air filter	Clean							X		X
	Replace								X	
Anti-vibration elements	Check	X						X		
	Have them replaced by a servicing dealer ¹⁾								X	
Air intake on fan housing	Clean		X		X					X
Cylinder fins	Clean		X			X				X
Carburetor	Check idle adjustment – saw chain must not rotate	X		X						
	If the saw chain rotates in idle, have the chain saw serviced by a servicing dealer ¹⁾									X
Spark plug	Adjust electrode gap							X		
	Replace after 100 hours of operation									X
Accessible screws, nuts and bolts	Tighten ²⁾									X
Spark arresting screen in muffler	Have checked by a specialist dealer ¹⁾							X		
	Have cleaned by a specialist dealer, or replaced if necessary ¹⁾								X	
Chain catcher	Check	X								
	Replace								X	
Exhaust bore	Decarbonise after 139 hours of operation, subsequently after every 150 hours of operation									X
Safety information label	Replace								X	
¹⁾ STIHL recommends STIHL servicing dealers ²⁾ During initial use of chain saws (with a power output of 3.4 kW or more), tighten the cylinder block screws after 10 to 20 hours of operation										

Main Parts

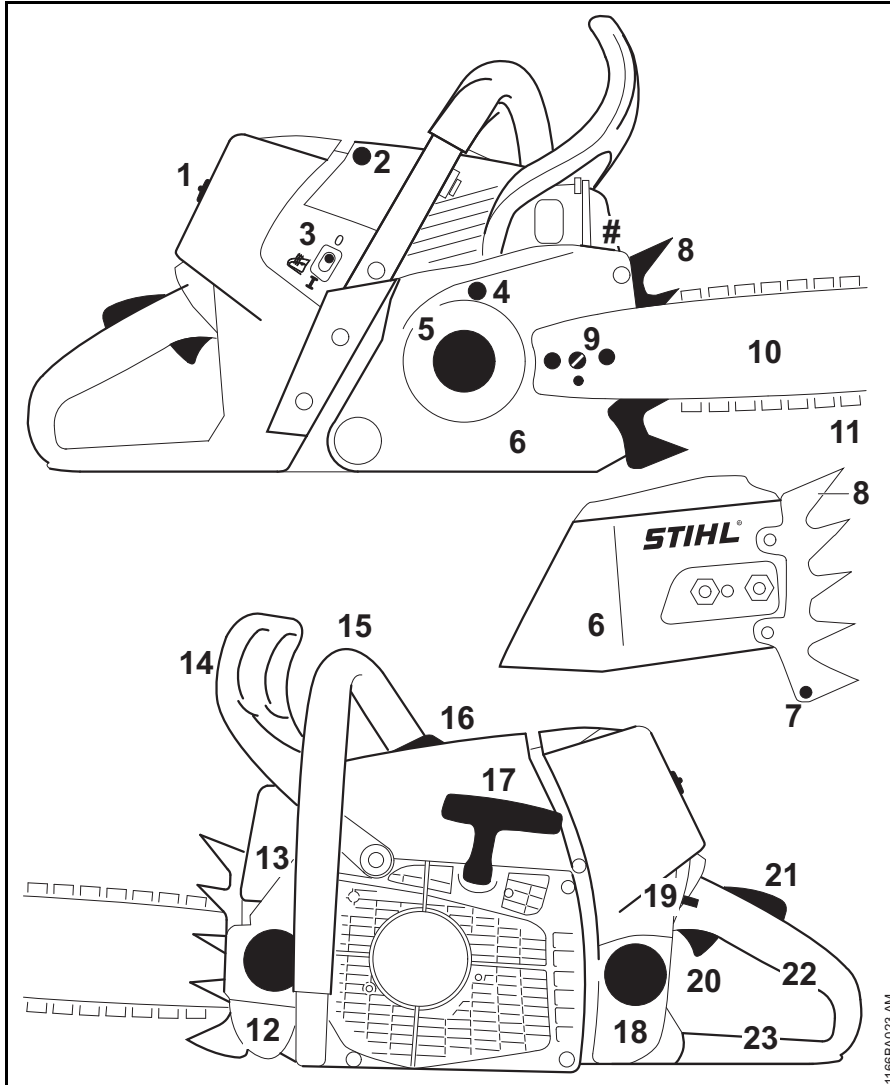

- 1 Filter cover cap
- 2 Spark plug boot
- 3 Handle heating switch (depending on equipment version)
- 4 Chain brake
- 5 Chain sprocket
- 6 Chain sprocket cover
- 7 Chain catcher
- 8 Bumper spike
- 9 Chain tensioner
- 10 Guide bar
- 11 Oilomatic saw chain
- 12 Oil filler cap
- 13 Muffler
- 14 Front hand guard
- 15 Front handle (handlebar)
- 16 Decompression valve
- 17 Starter grip
- 18 Fuel filler cap
- 19 Master control lever
- 20 Throttle trigger
- 21 Throttle trigger lockout
- 22 Rear handle
- 23 Rear hand guard
- # Machine number

1166BA023 AM

Specifications

Engine

STIHL single cylinder two-stroke engine

Displacement:	91.1 cm ³
Cylinder bore:	56 mm
Piston stroke:	37 mm
Engine power according to ISO 7293:	5.4 kW (7.3 HP) at 9500 rpm
Idle speed: ¹⁾	2800 rpm

¹⁾ to ISO 11681 +/- 50 rpm

Ignition system

Electronic magneto ignition (breakerless)

Spark plug (suppressed):	Bosch WSR 6 F, NGK BPMR 7 A
Electrode gap:	0.5 mm

Fuel system

All position diaphragm carburettor with integral fuel pump

Fuel tank capacity: 850 cm³ (0.85 l)

Chain lubrication

Fully automatic, speed-controlled oil pump with reciprocating piston - additional manual oil flow control

Oil tank capacity: 400 cm³ (0.4 l)

Weight

Dry, without cutting attachment	
MS 661 C-M	7.4 kg
MS 661 C-M with handle heating	
	7.5 kg

Cutting Attachment

Actual cutting length may be less than the specified length

Rollomatic E guide bars

Cutting lengths:	40, 45, 50, 63 cm
Pitch:	3/8"
Groove width:	1.6 mm
Sprocket nose:	10-tooth with cutting lengths 40, 45, 50 cm 11-tooth with cutting lengths 40, 45, 50, 63 cm

Rollomatic ES guide bars

Cutting lengths:	40, 45, 50, 55, 71, 75, 80, 90 cm
Pitch:	3/8"
Groove width:	1.6 mm
Sprocket nose:	11-tooth

Rollomatic ES Light guide bars

Cutting lengths:	71, 80, 90 cm
Pitch:	3/8"
Groove width:	1.6 mm
Sprocket nose:	11-tooth

Saw chains 3/8"

Rapid Micro (36 RM) Type 3652	
Rapid Super (36 RS) Type 3621	
Rapid Super 3 (36 RS3) Type 3626	
Pitch:	3/8" (9.32 mm)
Drive link gauge:	1.6 mm

Chain sprocket

7-tooth for 3/8" (rim sprocket)	
Max. chain speed to ISO 11681:	27.5 m/s
Chain speed at maximum power output:	21.7 m/s

Sound and vibration levels

For further details concerning compliance with the Physical Agents Directive Vibration 2002/44/EC, see www.stihl.com/vib/

Sound pressure level L_{peq} to ISO 22868

105 dB(A)

Sound power level L_w to ISO 22868

118 dB(A)

Vibration level $a_{hv,eq}$ to ISO 22867

Left handle:	6.9 m/s ²
Right handle:	5.6 m/s ²

The K-factor in accordance with Directive 2006/42/EC is 2.0 dB(A) for the sound pressure level and sound power level; the K-factor in accordance with Directive 2006/42/EC is 2.0 m/s² for the vibration level.

REACH

REACH is an EC regulation and stands for the Registration, Evaluation, Authorisation and Restriction of Chemical substances.

For information on compliance with the REACH regulation (EC) No. 1907/2006 see www.stihl.com/reach.

Exhaust Emissions

The CO₂ value measured in the EU type approval procedure is specified at www.stihl.com/co2.

The measured CO₂ value was determined on a representative engine in accordance with a standardized test procedure under laboratory conditions and does not represent either an explicit or implied guarantee of the performance of a specific engine.

The applicable exhaust emission requirements are fulfilled by the intended usage and maintenance described in this instruction manual. The type approval expires if the engine is modified in any way.

Ordering Spare Parts

Please enter your saw model, serial number as well as the part numbers of the guide bar and saw chain in the spaces provided. This will make re-ordering simpler.

The guide bar and saw chain are subject to normal wear and tear. When purchasing these parts, always quote the saw model, the part numbers and names of the parts.

Model

--	--	--	--	--	--	--	--	--	--	--	--	--	--	--	--	--	--	--	--	--

Serial number

--	--	--	--	--	--	--	--	--	--	--	--	--	--	--	--	--	--	--	--	--

Guide bar part number

--	--	--	--	--	--	--	--	--	--	--	--	--	--	--	--	--	--	--	--	--

Chain part number

--	--	--	--	--	--	--	--	--	--	--	--	--	--	--	--	--	--	--	--	--

Maintenance and Repairs

Users of this machine may only carry out the maintenance and service work described in this user manual. All other repairs must be carried out by a servicing dealer.

STIHL recommends that you have servicing and repair work carried out exclusively by an authorized STIHL servicing dealer. STIHL dealers are regularly given the opportunity to attend training courses and are supplied with the necessary technical information.

When repairing the machine, only use replacement parts which have been approved by STIHL for this power tool or are technically identical. Only use high-quality replacement parts in order to avoid the risk of accidents and damage to the machine.

STIHL recommends the use of original STIHL replacement parts.

Original STIHL parts can be identified by the STIHL part number, the **STIHL** logo and the STIHL parts symbol  (the symbol may appear alone on small parts).

Disposal

Observe all country-specific waste disposal rules and regulations.

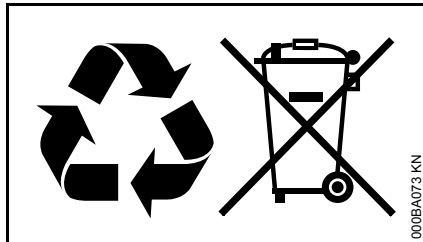

STIHL products must not be thrown in the garbage can. Take the product, accessories and packaging to an approved disposal site for environment-friendly recycling.

Contact your STIHL servicing dealer for the latest information on waste disposal.

EC Declaration of Conformity

ANDREAS STIHL AG & Co. KG
Badstr. 115
D-71336 Waiblingen

Germany

declare in exclusive responsibility that the product

Category: Chain saw
Make: STIHL
Model: MS 661 C-M
Serial identification: 1144
Displacement: 91.1 cc

conforms to the relevant provisions of Directives 2006/42/EC, 2014/30/EU and 2000/14/EC and has been developed and manufactured in compliance with the following standards in the versions valid on the date of production:

EN ISO 11681-1, EN 55012,
EN 61000-6-1

The measured and guaranteed sound power levels were determined according to Directive 2000/14/EC, Annex V, using the ISO 9207 standard.

Measured sound power level

118 dB(A)

Guaranteed sound power level

120 dB(A)

The EC type examination was carried out by

DPLF

Deutsche Prüf- und Zertifizierungsstelle
für Land- und Forsttechnik (NB 0363)
Spremlerger Straße 1
D-64823 Groß-Umstadt

Certification No.

K-EG-2012/6332

Technical documents deposited at:

ANDREAS STIHL AG & Co. KG
Produktzulassung (Product Licensing)

The year of manufacture and serial number are applied to the product.

Done at Waiblingen, 28.10.2016

ANDREAS STIHL AG & Co. KG

A handwritten signature in black ink that reads 'Thomas Elsner'.

Thomas Elsner

Director Product Management and Services

The CE mark, consisting of the letters 'C' and 'E' in a stylized, bold font.

0458-759-8321-B

AUS



www.stihl.com



0458-759-8321-B